



Carson

zOrb

Digital Viewer
Instruction Manual

MM-480

Table of Contents

1.Introduction	1
1.1 The Digital Viewer Introduction.....	1
1.2 Product Detail.....	1
1.3 Computer Requirement.....	1
1.4 Product Guide.....	2
1.5 Product Specification.....	3
2.Digital Viewer Software Installation	4
2.1 Microsoft® Windows 98SE.....	4
2.2 Microsoft® Windows ME.....	8
2.3 Microsoft® Windows 2000.....	11
2.4 Microsoft® Windows XP.....	15
2.5 Microsoft® Windows Vista.....	17
2.6 Apple Macintosh Computer OSX 10.4or above.....	20
3.Uninstalling the Digital Viewer Software	24
3.1 For Microsoft® Windows Operating System.....	24
3.2 For Apple Macintosh Computer Operating System.....	25
4.The Digital Viewer Operation	29
5.The Digital Viewer Software Operation for Microsoft® Window Operating System	32
5.1 PC Cam Mode: Pull Down Menu.....	32
A)Pull Down Menu ~ File.....	33
B)Pull Down Menu ~ Devices.....	34
C)Pull Down Menu ~ Options.....	35
D)Pull Down Menu ~ Capture.....	42
E)Pull Down Menu ~ Help.....	44
5.2 PC Cam Mode: Video Capture.....	45
5.3 Still Image Capture Window: Pull Down Menu.....	46
A)Pull Down Menu ~ File.....	48
B)Pull Down Menu ~ Edit.....	49
C)Pull Down Menu ~ Help.....	50
6.The Digital Viewer Software Operation for Apple Macintosh Operating System (OSX. 10.4 or above)	51
6.1 Monitor Mode: Pull Down Menu.....	51
A)Pull Down Menu ~ File.....	52
B)Pull Down Menu ~ Edit.....	53
C)Pull Down Menu ~ Monitor.....	54
6.2 Monitor Mode: Video Capture.....	63
A) Record Without Hogging Machine.....	63
B) Record Until MouseClick.....	64
6.3 Still Image Capture.....	65
7. Care & Storage	66
8. Warning	66

1. Introduction

1.1 The Digital Viewer Introduction

The Digital Viewer is battery-free and connects to the computer by USB cable. The Digital Viewer is equipped with a Optical VGA resolution PC camera which allows viewing on computer monitor, video capturing and still image capturing of observed object.

Video and still image taken by the Digital Viewer can be saved for further editing or record keeping.

1.2 Product Detail

- Digital Viewer 1 pc
- Software Installation CD 1 pc
- Instruction Manual 1 pc
- Two base adapters

1.3 Computer Requirement

For Windows® Operating System

Ram: 128Mb for Windows 98SE, ME

256Mb for 2000, XP, and 512Mb for Vista

CPU: P4-1.8G

Display: 32 bit

Display Ram: 64M

USB: USB 2.0

Hard Disk Free Space: 800Mb

For Apple Macintosh Computer

Ram: 128Mb

Operating System: Mac OS X version 10.4 or later

CPU: PowerPC G3/G4/G5 or Intel-based
Macintosh computers.

Display: Require QuickTime 6.5.1 or later on
Mac OS X 10.4.

USB: USB 2.0

Hard Disk Free Space: 800Mb

1.4 Product Guide

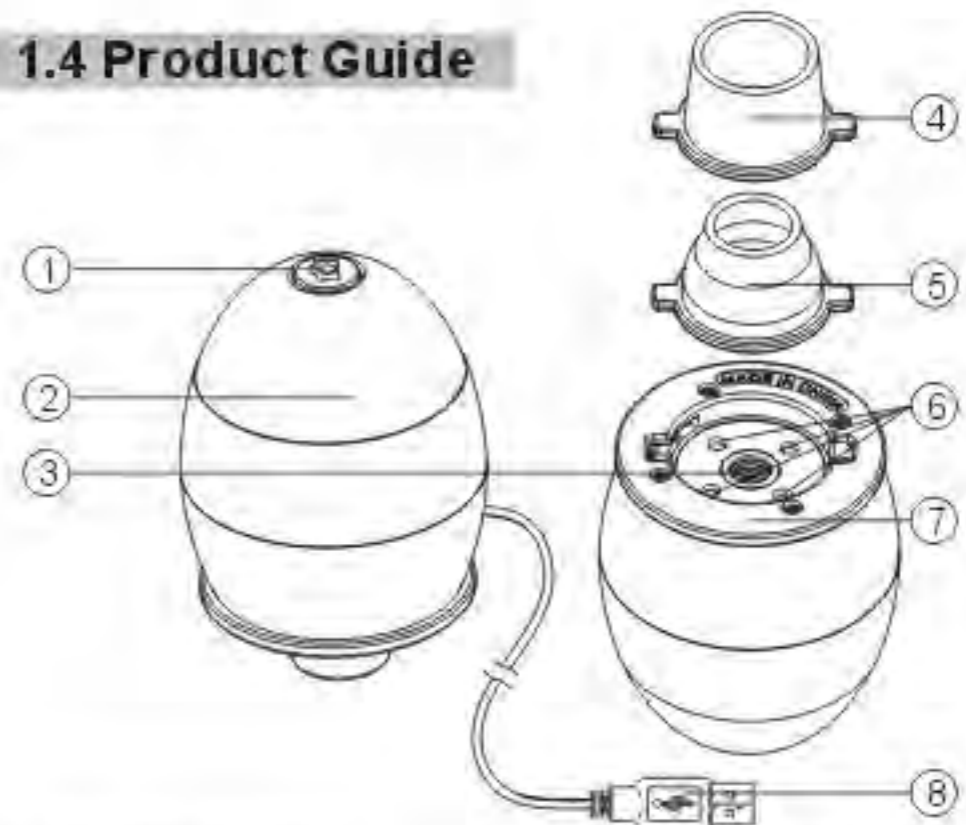

1. Shutter Button
2. Focusing Ring
3. Lens
4. Large Adaptor

5. Small Adaptor
6. LED Illumination
7. Adaptor slot
8. USB Cable

1.5 Product Specification

White Balance: Auto

Interface: USB 2.0

Image Sensor: 350,000 pixel VGA CMOS

Image Resolution: 640 X 480 Pixels (VGA)

Photo Capture: One-touch

Illumination: Built-in LED

Capture Image Resolution: 640 X 480 VGA
(Interpolation up to 1600 X 1200 pixels.)

Note: Interpolation requires DirectX 9.0 or above
for Windows® Operating System.

Interpolation up to 1280 X 960 pixels for
Mac Operating System.)

Exposure: Auto

Luminosity: 3 Lux

Power: USB Cable connection to PC or MAC

Product Weight: 104g

Product Size: 50X50X74mm

Magnification: 35X on a 14" Screen

43X on a 17" Screen

53X on a 21" Screen

Software Compatible Operation System:

Microsoft® Windows 98SE, Windows ME,

Windows 2000, Windows XP, Window Vista,

Mac OSX 10.4 or above

Macintosh, Mac OS, Mac is a trademark of Apple Inc., registered in
the U.S. and other countries.

2. The Digital Viewer Software Installation

➤ For Microsoft® Windows Operation System

Make sure that the Digital Viewer is not connected to the computer. Insert the Software Installation CD into the Compact Disc Drive of the PC. The Digital Viewer Driver Set-up dialog box will be displayed automatically (In case the set-up does not start automatically, locate the Compact Disc Drive and double click on the Setup.exe file). Simply follow the on-screen dialog box to complete the software installation.

➤ For Apple Macintosh Operating System

Make sure that the Digital Viewer is not connected to the computer. Insert the Software Installation CD into the Compact Disc Drive of the Macintosh Computer. Locate the Compact Disc Drive and click on the file named "Digital Viewer Driver OSX 1.01.001.dmg". Simply follow the on-screen dialog box to complete the software installation.

Please refer to the below sub-sections for details of installation on different Operating Systems.

2.1 Microsoft® Windows 98SE

- The Digital Viewer Driver Set-up dialog box will be displayed automatically.
Click "Install"



Select "Finish" to complete the installation and restart the computer manually.



- After the PC restarts, plug the USB cable into the USB port of the PC. When the Digital Viewer is connected to the computer for the first time, The following dialogue box will appear and the "New Hardware Found" will be displayed.

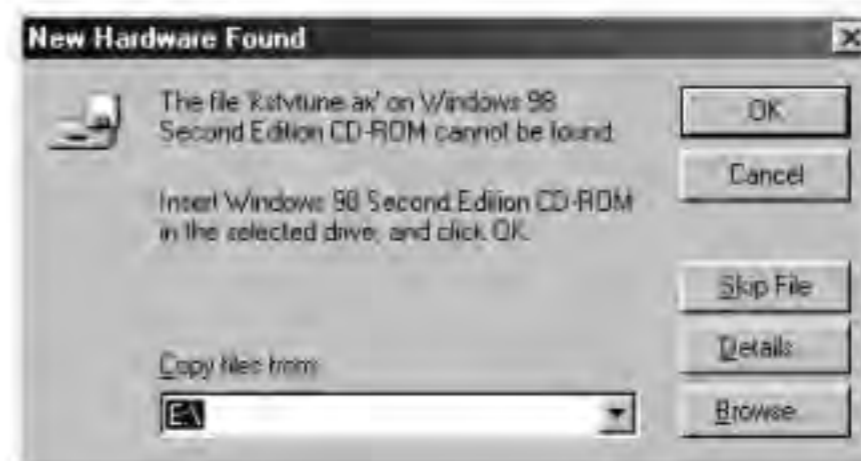

Insert Windows 98SE CD-ROM into the CD-ROM drive, click "OK" to continue.
Note: If you do not have the Windows® 98SE CD-ROM, click "Cancel" to abort installation. The Digital Viewer cannot be successfully installed without the Windows® 98SE CD-ROM.

When the hardware installation is completed, short-cut icons will appear in the "Programs" and "Taskbar" of the PC. The Digital Viewer can also be located in the "System Properties" under Imaging Device.

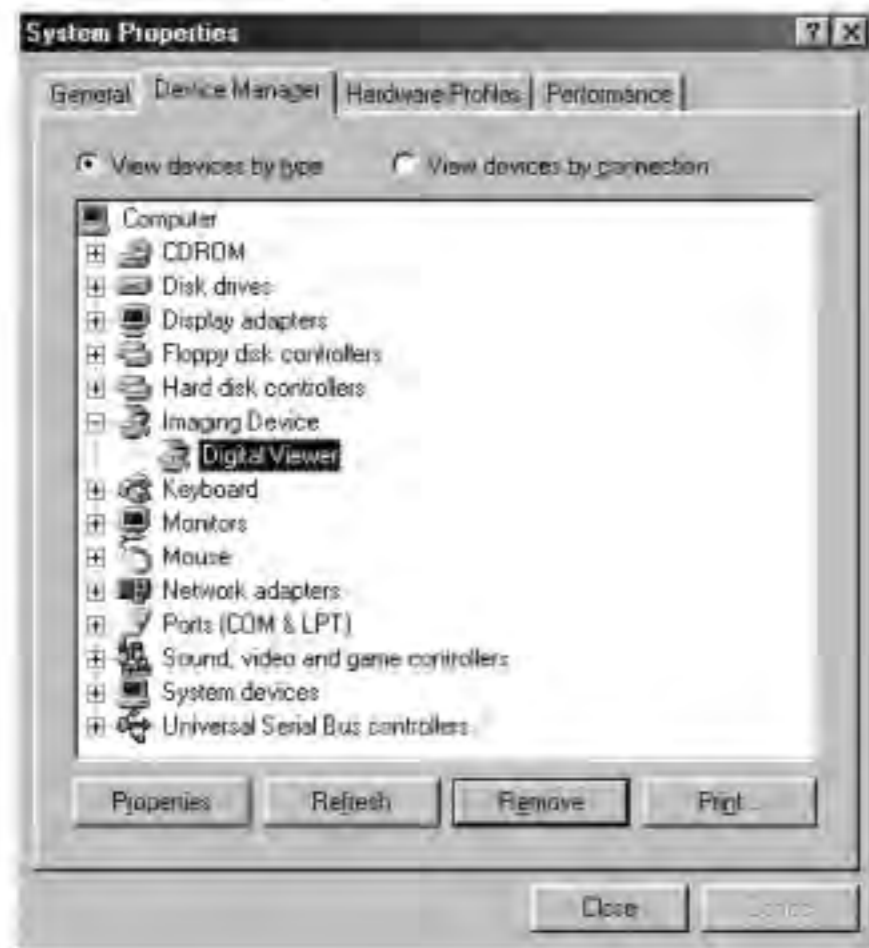

2.2 Microsoft® Windows ME

- The Digital Viewer Driver Set-up dialog box will be displayed automatically.
Click "Install"



Select "Finish" to complete the installation and restart the computer manually.



- After the PC restarts, plug the USB cable into the USB port of the PC. The following dialogue box will appear and the PC will automatically proceed to the hardware installation of the Digital Viewer.

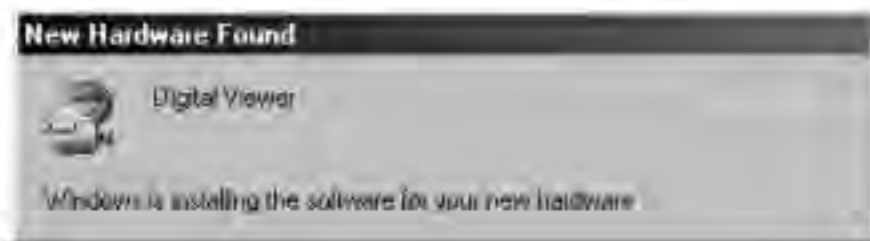

When the hardware installation is completed, short-cut icons will appear in the "Programs" and "Taskbar" of the PC. The Digital Viewer can also be located in the "System Properties" under Imaging Device.



2.3 Microsoft® Windows 2000

- The Digital Viewer Driver Set-up dialog box will be displayed automatically.

Click "Install"



Select "Finish" to complete the installation and restart the computer.



- After the PC restarts, plug the USB cable to the USB port of the PC. The following dialogue box will appear and the PC will automatically proceed to the hardware installation of the Digital Viewer.



Click "Finish"

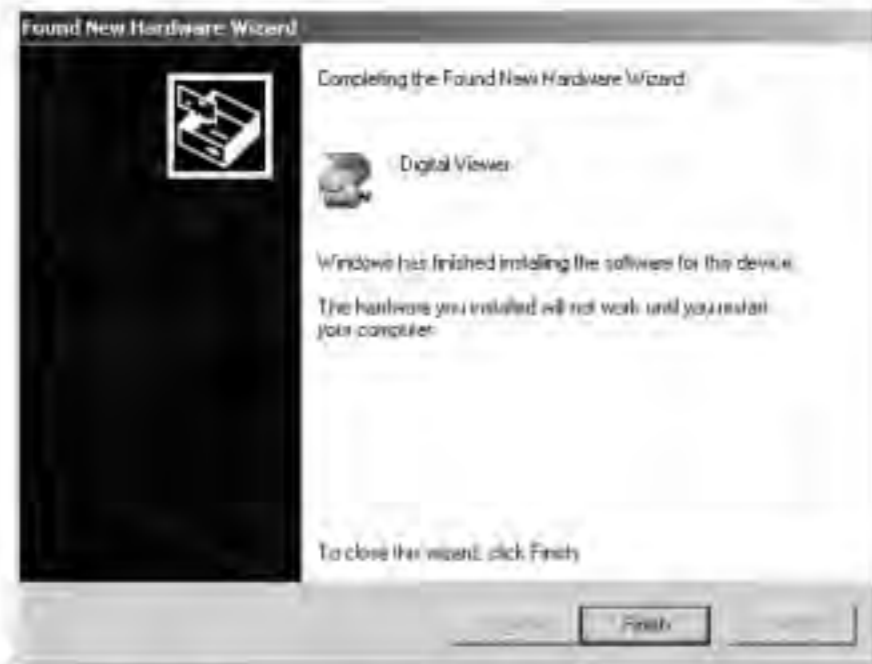

A dialogue box will pop up prompting to restart the computer. Click "Yes" to restart computer

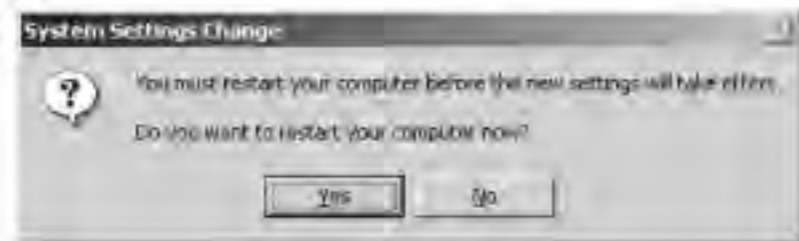

When the computer has been restarted, short-cut icons will appear in the "Programs" and "Taskbar" of the PC. The Digital Viewer can also be located in the "Device Manager" under Imaging Device.



2.4 Microsoft® Windows XP

- The Digital Viewer Driver Set-up dialog box will be displayed automatically. Click "Install"



Select "Finish" to complete installation and restart the computer manually.



- After the PC restarts, plug the USB cable to the USB port of the PC. The PC will automatically proceed to the hardware installation of the Digital Viewer.

When the hardware installation is completed, short-cut icons will appear in the "Programs" and "Taskbar" of the PC. The Digital Viewer can also be located in the "System Properties" under Imaging Device.





2.5 Microsoft® Windows Vista

- The Digital Viewer Driver Set-up dialog box will be displayed automatically.
Click "Install"



Select "Finish" to complete installation and restart the computer manually.



- After the PC restarts, plug the USB cable to the USB port of the PC and the PC will automatically complete the Hardware Installation.

When the hardware installation is completed, Short-cut icons will appear in the "Program List", "Desktop" and "Taskbar" of the PC. The Digital Viewer can also be located in the "Device Manager" under Imaging Device.



2.6 Macintosh OSX 10.4 or above

- Insert the Software Installation CD into the Compact Disc Drive of the Macintosh Computer. Locate the Compact Disc Drive and click on the file named "Digital Viewer Driver OSX 1.01.001.dmg".



An icon "Digital Viewer Driver OSX 1.01.0001" will appear on the desktop. Click the icon and a window will appear.



Double click on the icon "Digital Viewer Driver Install" and a Installation dialogue box will be displayed automatically



Click "Continue"



Click "Continue"

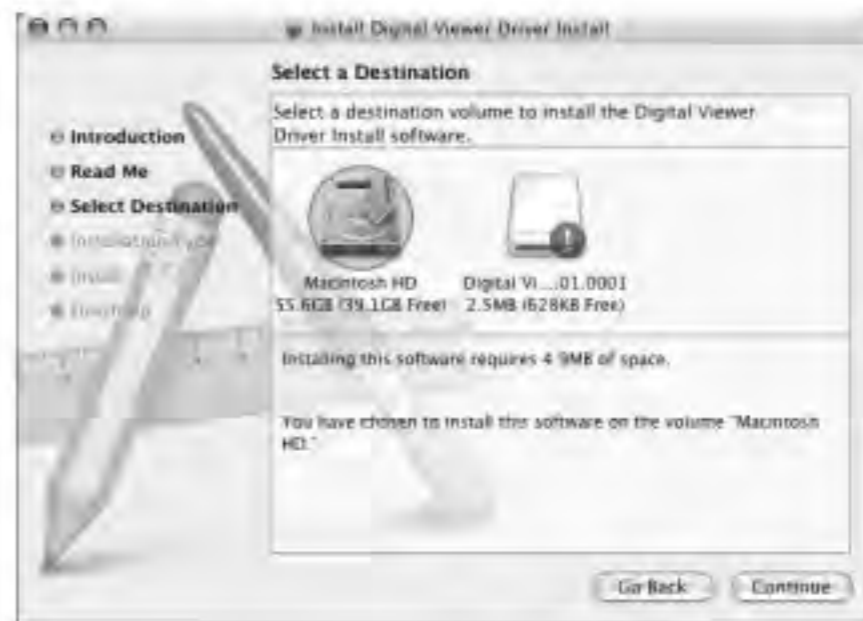

Click "Continue"



Click "Install"



An "Authenticate Window" will appear prompting for the default Administrator password of the Operating System. Enter the password and click "OK". (Consult the computer administrator for password if not available)

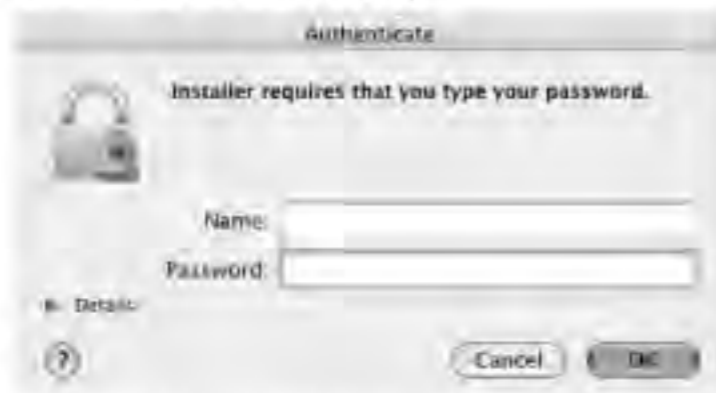

Click "Close" to complete installation. An icon of the Digital Viewer will appear on the desktop.



➤ Plug the USB cable into the USB port of the Macintosh Computer and it is ready to use.

3. Uninstalling the Digital Viewer Software

3.1. Microsoft® Windows Operating System

Click on the "Start" located at the desktop, then choose "Program" and locate "Digital Viewer" inside the program list. Select "Uninstall". Or, go to "Control Panel" of the PC and double click on the "Add/Remove Programs". Locate the Digital Viewer software in the "Add/Remove Programs" list and click "Remove".

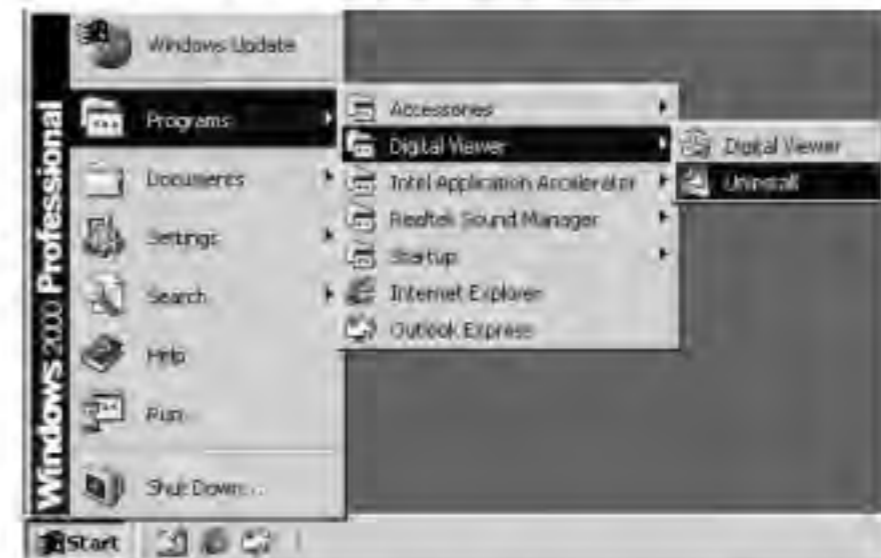

The following dialogue box will appear, click "Yes" to confirm or "No" to exit uninstalling.

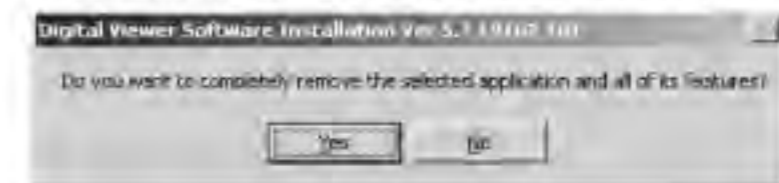

After successfully uninstalling the software, click "Finish".



Restart the PC and the software will be completely removed from the PC.

3.2. Apple Macintosh OSX 10.4 or above

Insert the Software Installation CD into the Compact Disc Drive of the Macintosh Computer. Locate the Compact Disc Drive and click on the file named "Digital Viewer Driver OSX 1.01.001.dmg".

An icon "Digital Viewer Driver OSX 1.01.0001" will appear on the desktop. Click the icon and a window will appear.



Double click on the icon "Digital Viewer Driver Uninstall" and a set-up dialogue box will be displayed automatically



Click "Continue"



Click "Continue"



Click "Install"



Click "Continue"



An "Authenticate Window" will appear prompting for the default Administrator password of the Operating System. Enter the password and click "OK". (Consult the computer administrator for password if not available)



Click "Close" to complete the un-installation. The software is completely removed from the Macintosh Computer.



4. The Digital Viewer Operation

To View the images clearly, please use one of the adaptors provided.

- 4.1 Choose an adaptor based on the size of the object bring viewed, place it onto the adaptor slot located under the main body. Lock by turning in clockwise direction.

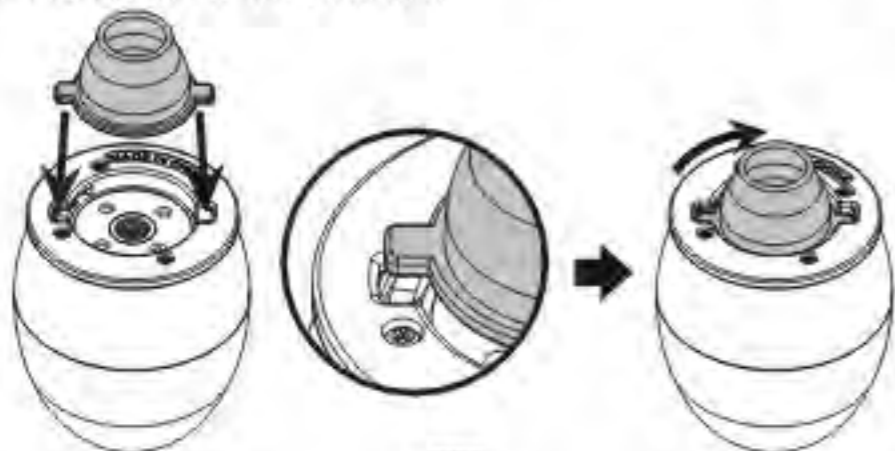

- 4.2 Connect the USB Cable (4) of the Digital Viewer to a USB port of the computer. The LED light will turn on indicating that the Digital Viewer is powered on.
- 4.3 Start up the Digital Viewer software which is installed in the computer (Refer to Chapter 5 and 6 of this Instruction Manual for detailed operating instruction of the software).
- 4.4 Rotate the Focusing Ring (2) clockwise or anticlockwise until the observation image shown on the monitor is clear and sharp (See figures below).





- 4.5 Image can be captured by pressing the Shutter Button (1) on the Digital Viewer

(Refer to Chapter 5.3 and 6.3 of this Instruction Manual for detailed instruction on saving and capturing images).

5. The Digital Viewer Software Operation for Microsoft® Window Operating System

5.1 PC Cam Mode: Pull Down Menu

Double click the "Digital Viewer" short-cut icon on the Desktop of the PC to open the program.



A) Pull Down Menu ~ File



- **Set Capture File:**
Saving the video file
- **Allocate File Space:**
Set up the disk space allocated for video files. The default is set at minimum allocated disk space of 1MB. PC will automatically adjust the required disk space when needed.

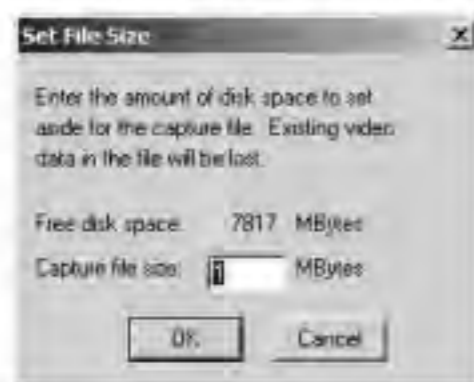

- **Save Captured Video As:**
Saving the video file in another directory or under another file name.

B) Pull Down Menu ~ Devices



- **Digital Viewer:**
Indicate the Imaging Device in use. If other Imaging Devices are available, make sure "Digital Viewer" is selected.

C) Pull Down Menu ~ Options



➤ **Preview:**

When checked, the software is operating under PC Cam Mode and the Digital Viewer can be used for normal object observation.

➤ **Audio Format:**

The Digital Viewer is not equipped with this function.

➤ **Video Capture Filter:**

Image Setting such as Brightness, Contrast, Gamma, Hue, Saturation, Sharpness, White Balance etc. See below dialog box for reference.

Settings

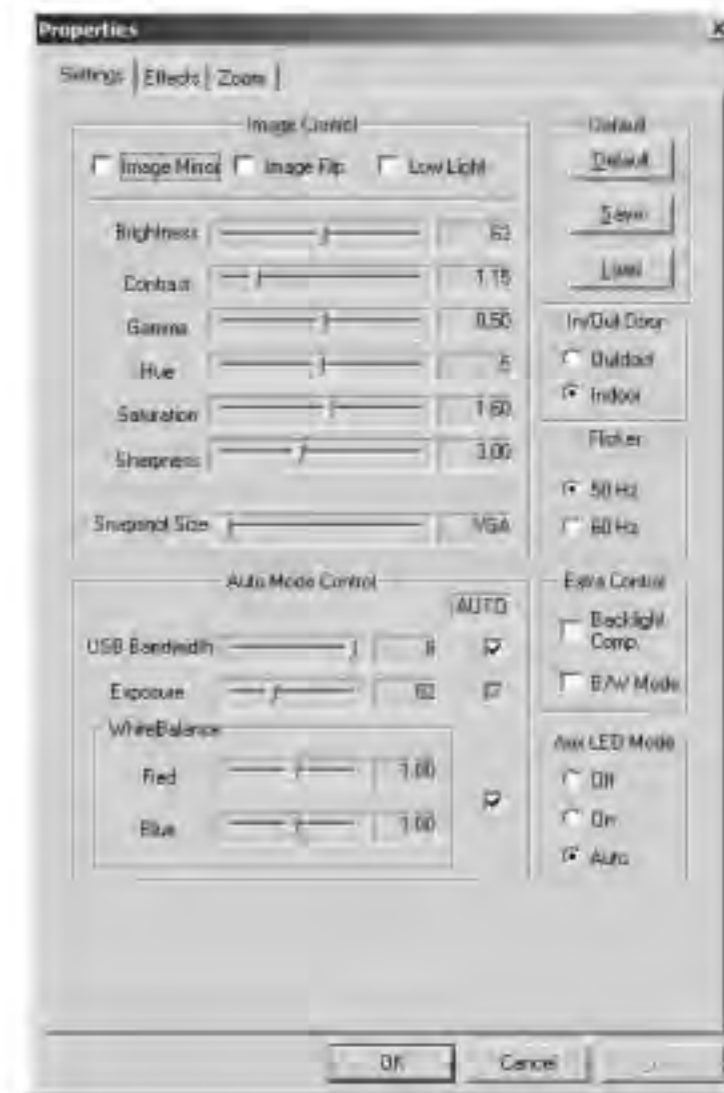

When the image shown on the monitor appears dark, check the "Low Light" box for brighter image.

When completed, click "Apply" then "OK" or simply click "OK".

Effects



Add special effects to the image shown on the monitor.

When completed, click "Apply" then "OK" or simply click "OK".

Note: Effects can also be set by right clicking the Digital Viewer Icon located on the taskbar. Choose "Special Effect" to open the list of special effects available.

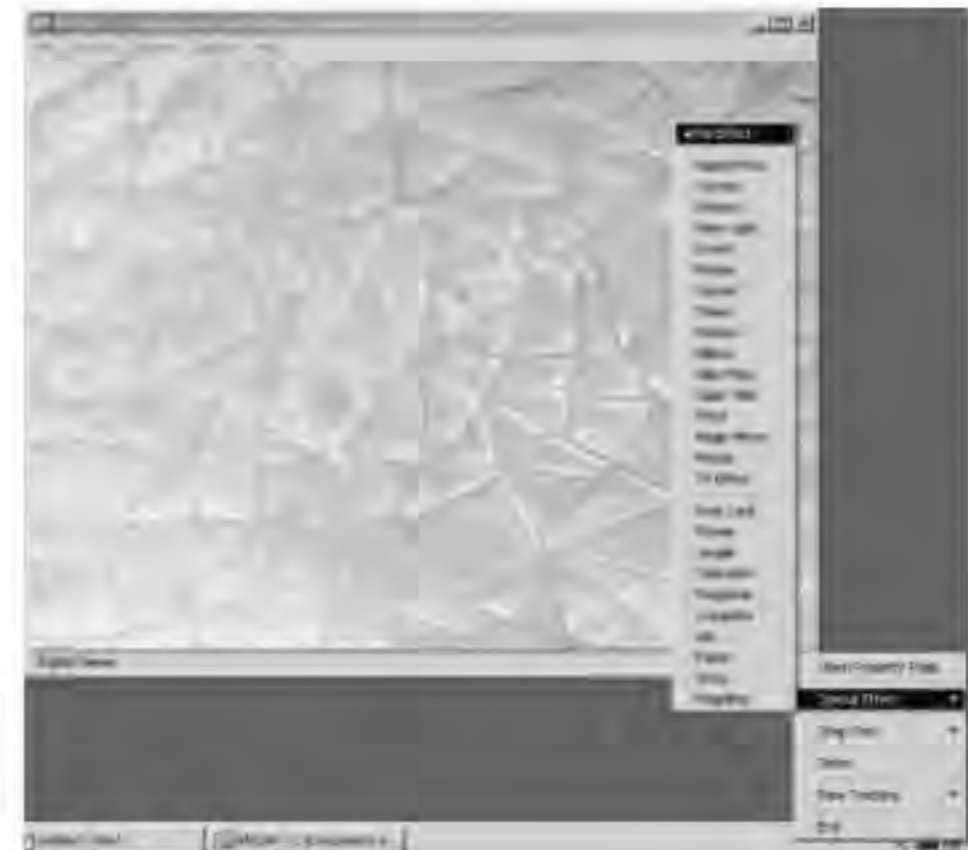

Zoom



Check "Enable Zoom" for enabling digital zoom (Not recommended. Enabling this function may cause blurry image)

When completed, click "Apply" then "OK" or simply click "OK".

➤ Video Capture Pin:

Select Desired video capture resolution. See below dialog box for reference.
DirectX 9.0 or above is required for Interpolation up 1600 X 1200 pixels.

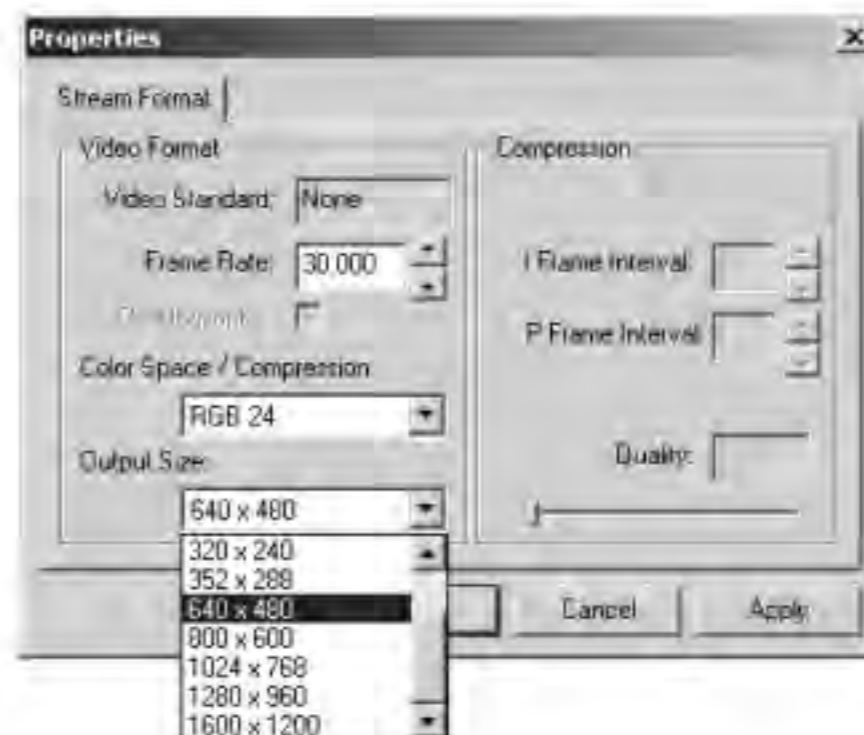

Images are observed at 640 X 480 pixels without interpolation

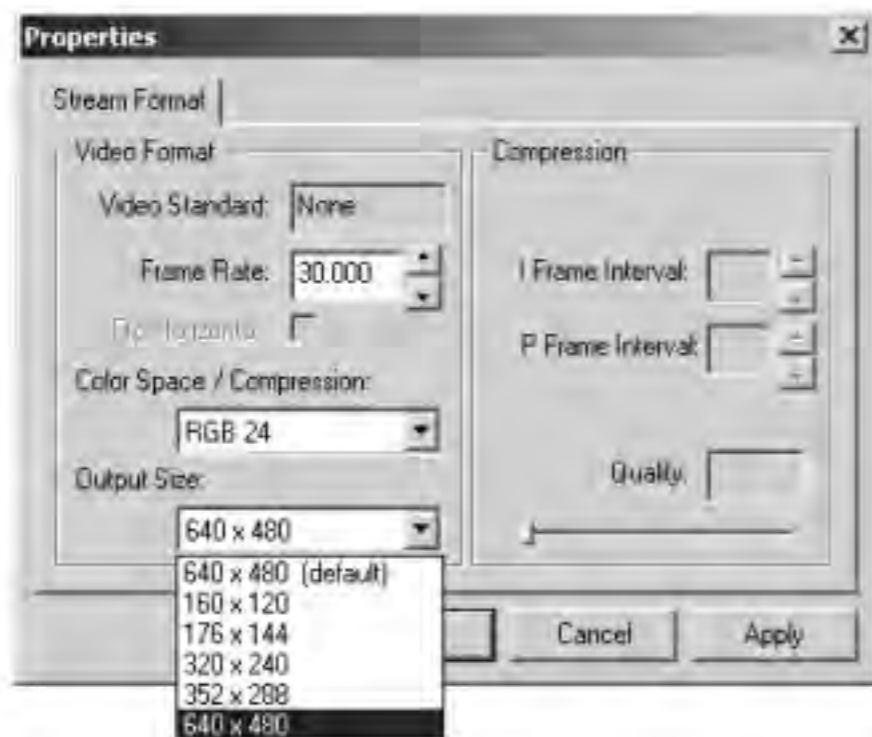

When completed, click "Apply" then "OK" or simply click "OK".

D) Pull Down Menu ~ Capture



- **Start Capture:**
Start video capturing.
- **Stop Capture:**
Stop video capturing.
- **Capture Audio:**
The Digital Viewer is not equipped with this function.
- **Master Stream:**
The Digital Viewer is not equipped with this function.

➤ **Set Frame Rate:**

Frame Rate Set-up. Default is set at 30f/sec.

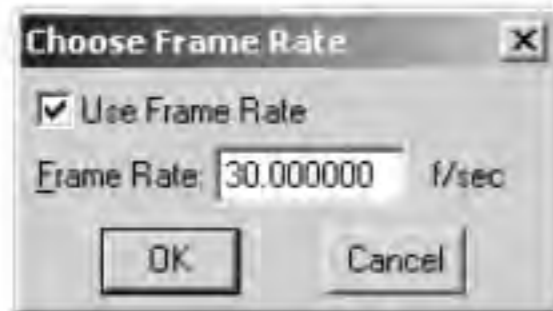

➤ **Set Time Limit:**

Set up time duration for video capturing. The software will automatically stop recording when reaching the pre-set time limit.

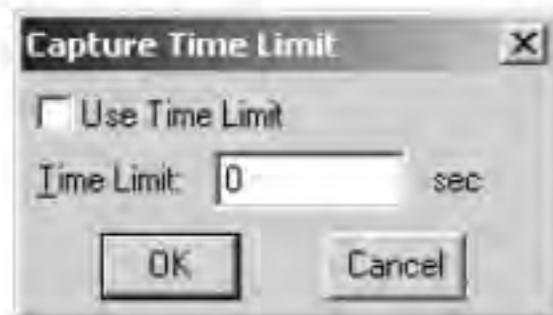

E) Pull Down Menu ~ Help



➤ **About:**

Information about the software.



5.2 PC Cam Mode: Video Capture

- Under the "Capture" pull down menu, set up the desired Frame Rate and Time Limit under "Set Frame Rate" and "Set Time Limit".
- Under the "File" pull down menu, select "Set Capture File" to select the directory for saving the video file. Enter the desired file name followed by [.avi] and click "Open". The following dialogue box will appear.

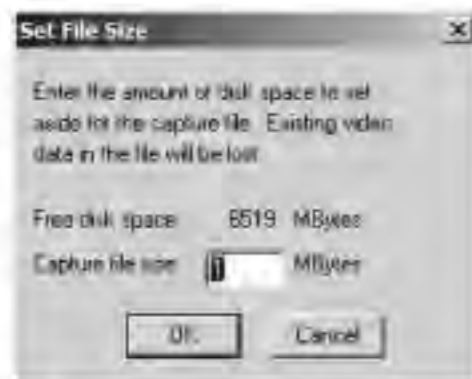

- Click "OK".
- Under the "Capture" pull down menu, select "Start Capture". The following dialogue box will appear.

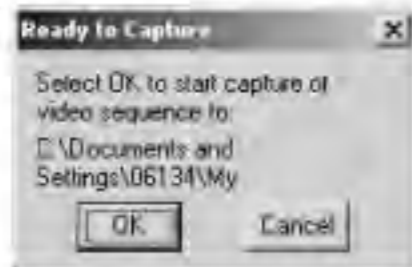

- Click "OK" to start video capturing. Move the Digital Viewer to capture desired areas of the observed object.

- If Time Limit is set, the Digital Viewer will stop capturing when the pre-set Time Limit is reached. If Time Limit is not set, under the "Capture" pull down menu, select "Stop Capture" to stop the video capturing.

5.3 Still Image Capture Window: Pull Down Menu

- Press once on the Shutter Button located on top of the Digital Viewer to capture still image. Another window will pop-out with the captured still image.



- Note: An image can also be captured by right clicking the Digital Viewer Icon located at the taskbar. Choose "Snap Shot" to capture an image.

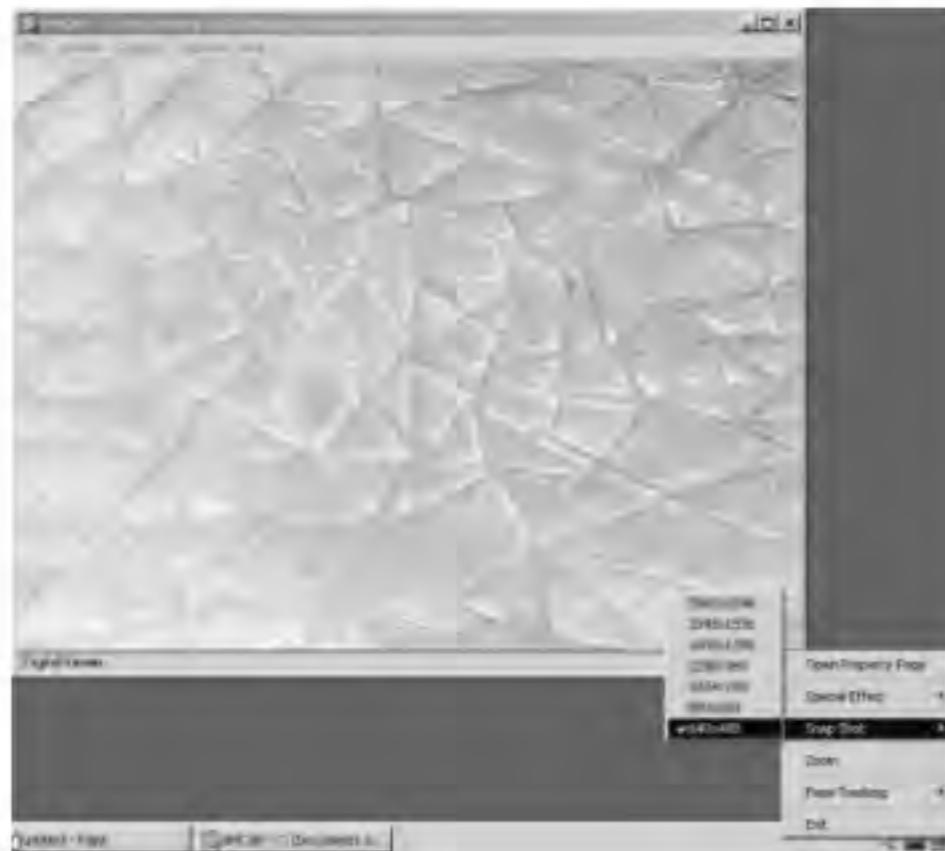

A) Pull Down Menu ~ File

- **Save as:** Saving the captured image in another file name.
- **Close:** Close the window



B) Pull Down Menu ~ Edit

- **Never Rotate:** The image will not be rotated.
- **Rotate 90 degrees CW:** The image will be rotated 90 degrees clockwise.
- **Rotate 90 degrees CCW:** The image will be rotated 90 degrees counter-clockwise.
- **Rotate 180 degrees:** The image will be rotated 180 degrees.

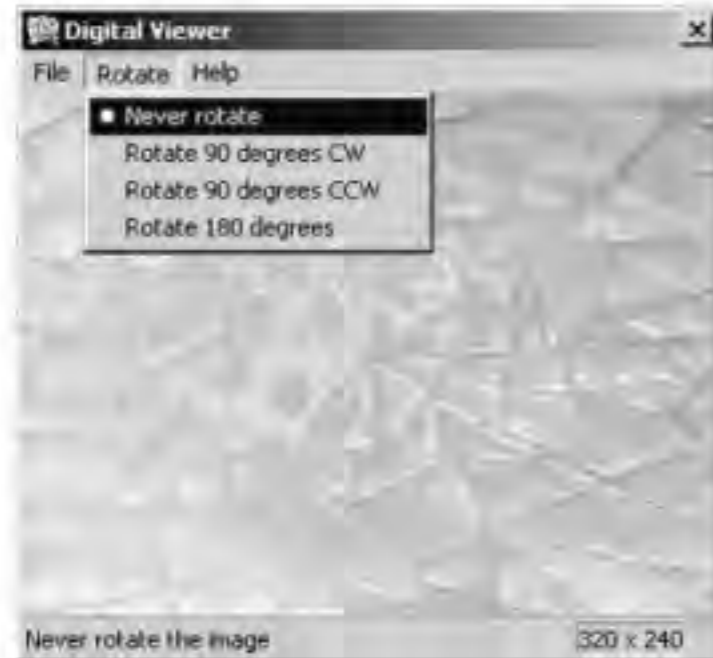

C) Pull Down Menu ~ Help

- **About Snapshot Viewer:** Information about the software.



6. The Digital Viewer Software Operation for Apple Macintosh Operating System

6.1 Monitor Mode: Pull Down Menu

Double click the "Digital Viewer" short-cut icon on the Desktop of the Macintosh computer to open the program.



A) Pull Down Menu ~ File

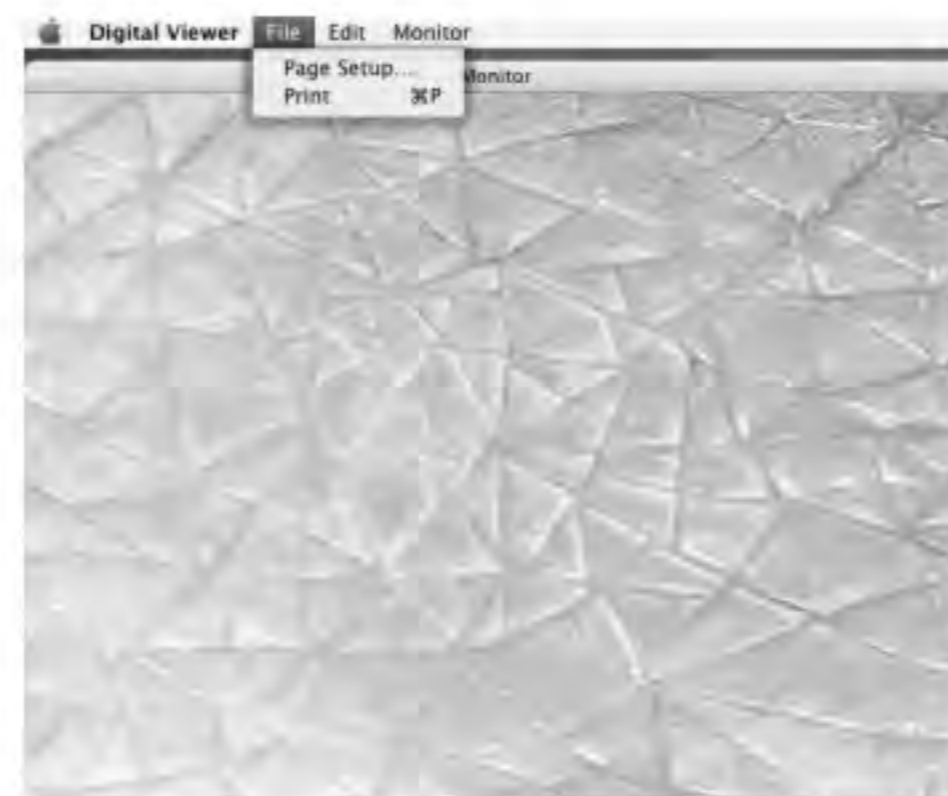

- **Page Set-up:**
The Digital Viewer is not equipped with this function.
- **Print:**
The Digital Viewer is not equipped with this function.

B) Pull Down Menu ~ Edit



- **Undo:**
The Digital Viewer is not equipped with this function.
- **Cut:**
Choose Cut to copy the current image to paste in other image editing software.
- **Copy:**
Choose Copy to copy the current image to paste in other image editing software.

- **Paste:**
The Digital Viewer is not equipped with this function.
- **Clear:**
The Digital Viewer is not equipped with this function.

C) Pull Down Menu ~ Monitor



➤ **Video Settings:
Digital Viewer ~ Image**

Image Settings such as Gamma, Exposure time, White Balance, Image file format etc. See below dialog box for reference.



Pull down the "Format" list to select desired video resolution. When completed, click "OK".



Digital Viewer ~ Digital Zoom

Slide the Zoom bar to enable digital zoom (Not recommended. Digital Zoom may cause blurry images)



When completed, click "OK".

Adjustment

Image Settings such as Hue, Saturation, Brightness, Contrast and Sharpness etc. See above dialog box for reference.



When completed, click "OK".

Compression

Select desired compression type and set frames per second for motion video. See below dialogue box.



When completed, click "OK".

Source

Select Video Source setting of NTSC, PAL or SECAM.



The Digital Viewer is not equipped with this function.

- **Sound Setting:**
The Digital Viewer is not equipped with this function.
- **Record Video:**
The Digital Viewer is not equipped with this function.
- **Record Sound:**
The Digital Viewer is not equipped with this function.

➤ **Quarter Size:**

When selected, the image will shrink to 1/4 of the original size.



➤ **Half Size:**

When selected, the image will shrink to 1/2 of the original size.



➤ **Full Size:** When selected, the image will appear full size.

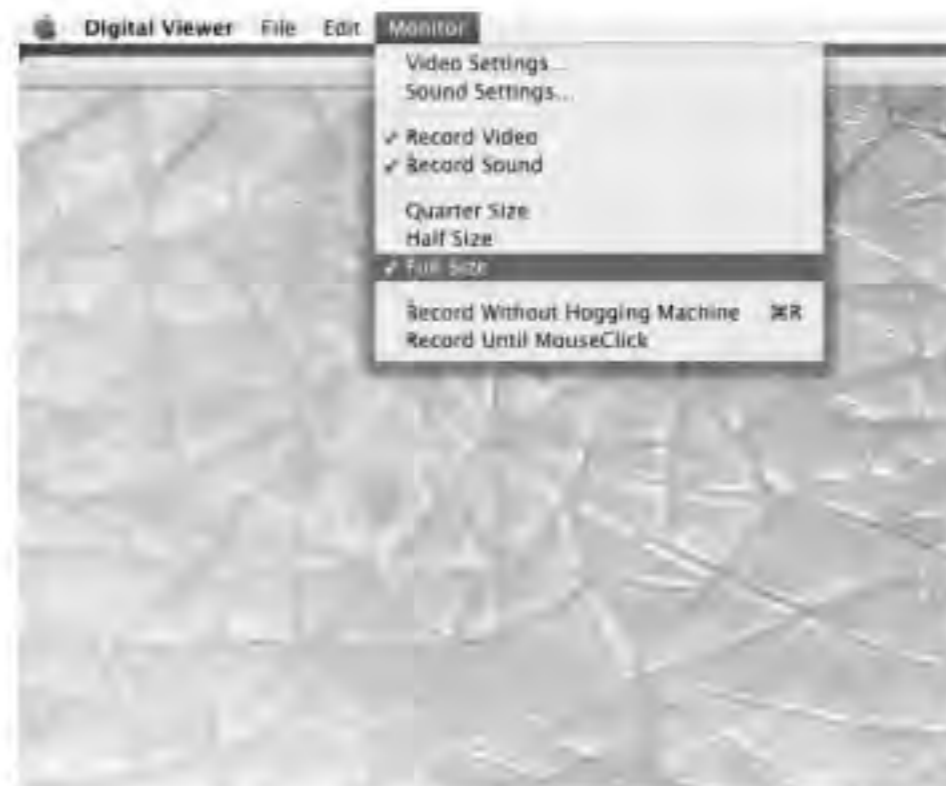

➤ **Record Without Hogging Machine:** Start Recording (Refer to Chapter 6.2 of the Instruction Manual for detailed operating instruction for Video Capture)

➤ **Record Until MouseClick:** Start Recording until the Mouse is clicked to stop recording. (Refer to Chapter 6.2 of the Instruction Manual for detailed operating instruction for Video Capture)

6.2 Monitor Mode: Video Capture

There are two ways to capture video.

A) Record Without Hogging Machine

- Under the "Monitor" pull down menu, select "Record Without Hogging Machine". A "Save" dialogue box will appear as below.

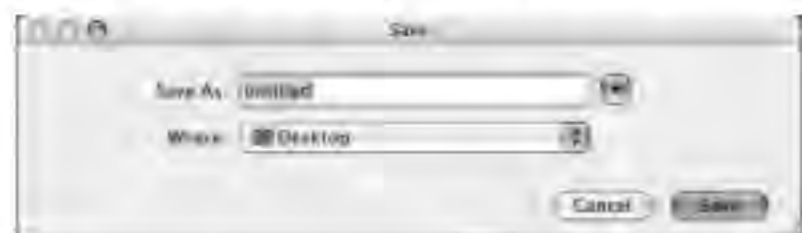

- Enter a desired file name and click "Save" to begin Video Capture.
- To stop Video Capture, under the "Monitor" pull down menu, select "Stop Recording". The following dialogue box will appear.

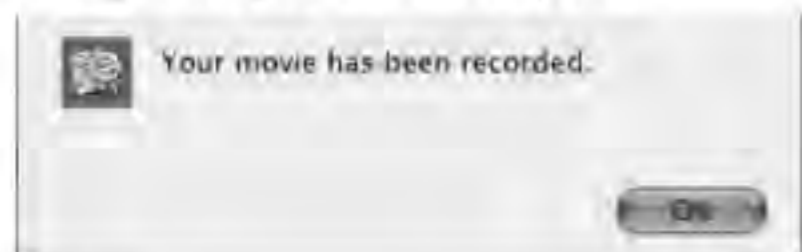

- Click "OK".

B) Record Until MouseClick

- Under the "Monitor" pull down menu, select "Record Until MouseClick". A "Save" dialogue box will appear as below.

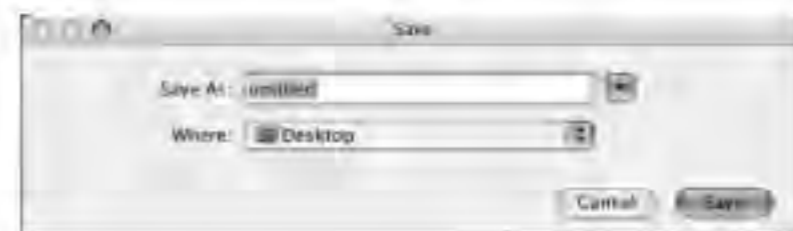

- Enter a desired file name and click "Save" to begin Video Capture.
- To stop Video Capture, click the mouse once. The following dialogue box will appear.



- Click "OK".

6.3 Still Image Capture



- Press once on the Shutter Button located on top of the Digital Viewer to capture still image. Another window will pop-out with the captured still image.
- The captured image will be automatically saved to the desktop of the Macintosh Computer.

7. Care & Storage

- Clean the Digital Viewer Casing with moistened cloth when necessary then wipe it dry. Never use chemical detergent to clean the Digital Viewer.
- Never leave the Digital Viewer in a damp or dusty place.
- In case the Digital Viewer will not be used for a prolonged time, store the Digital Camera in its original box and keep it in a well ventilated environment and away from extreme heat of direct sunlight.

8. Warning

- Never attempt to open or dismantle the Digital Viewer.
- To avoid possible permanent eye damage, do not place lighted Digital Viewer directly upon human eye.

zOrb Technical Support:

Phone support is available Monday through Friday from 9:00 am - 5:00 pm Eastern Standard Time. Phone: 631-963-5000.