

OWNER'S MANUAL

THE CENTURIONPRO ORIGINAL



ELITE TRIMMING TECHNOLOGIES

FOR MORE INFORMATION ON OUR PRODUCT LINE PLEASE VISIT

WWW.CPROSOLUTIONS.COM





CONTENTS

ENGLISH

Machine Assembly.....	3
Blade Removal & Cleaning.....	4
Cover Assembly.....	5
Blower Assembly.....	6
Blower Cleaning.....	7
Hopper Assembly.....	8
Warranty Information.....	9

ELITE TRIMMING TECHNOLOGIES

FOR MORE INFORMATION ON OUR PRODUCT LINE PLEASE VISIT

WWW.CPROSOLUTIONS.COM



▲ 110V
Operate at 110V only!

STEP 1
Lift Cover

STEP 2
Lift UPPER FRAME



Loosen four 1/4"
Sealing Bolts &
Washers

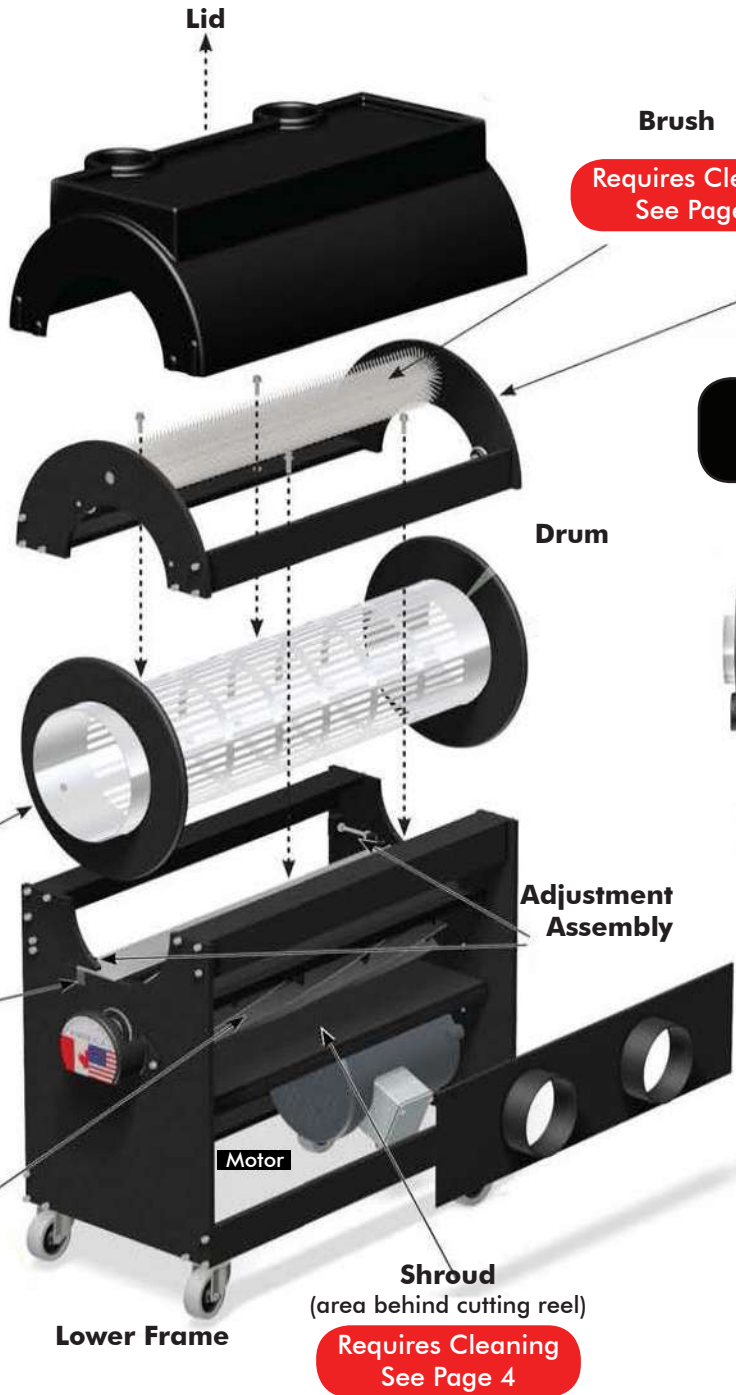

STEP 3
Lift the DRUM



Note the longer end of the
DRUM when re-installing

ELITE TRIMMING TECHNOLOGIES

FOR MORE INFORMATION ON OUR PRODUCT LINE PLEASE VISIT
WWW.CPROSOLUTIONS.COM



For optimal performance and life, the BED BAR BLADE must be removed then cleaned every few hours of operation.



Installation is reverse order of Removal

CLEANING

For optimal performance and life, the components must be cleaned every 3 to 4 days of use.

Instructions:

Clean with pressure-washing at 1500-2000 PSI, Hot Water, Fan Spray Setting

Run the CenturionPro for 15 minutes after washing, allowing components to dry

Avoid water contact on bearings



ELITE TRIMMING TECHNOLOGIES

FOR MORE INFORMATION ON OUR PRODUCT LINE PLEASE VISIT
WWW.CPROSOLUTIONS.COM



COVER ASSEMBLY

It is UNSAFE to operate the CENTURIONPRO without COVERS!

CenturionPro

STEP 1

Attach the PULLEY COVER to the CENTURIONPRO

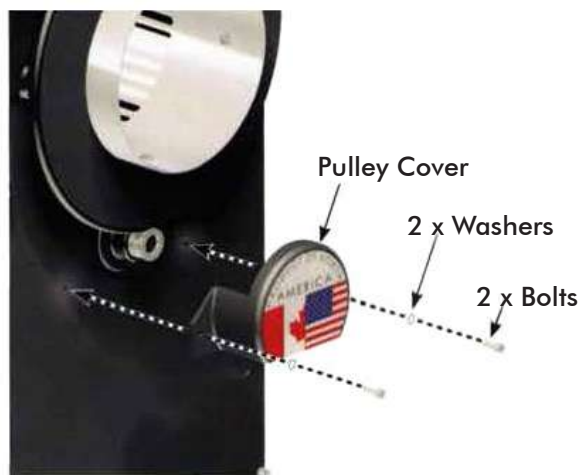

STEP 2

Attach the BELT COVER to the CENTURIONPRO

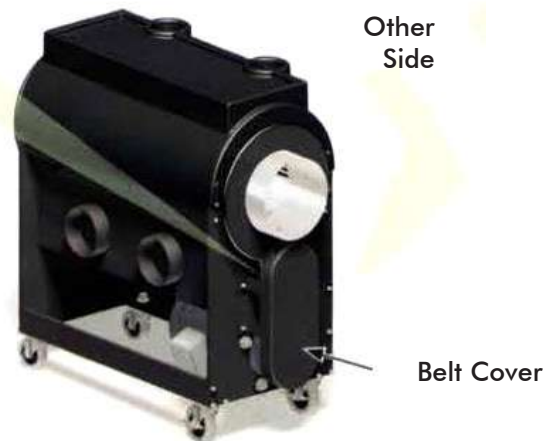
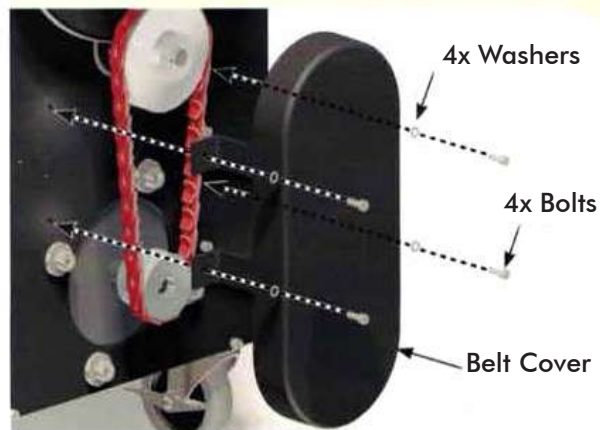

ELITE TRIMMING TECHNOLOGIES

FOR MORE INFORMATION ON OUR PRODUCT LINE PLEASE VISIT
WWW.CPROSOLUTIONS.COM



BLOWER ASSEMBLY

⚠ 110V
Operate at 110V only!



STEP 2
Attach 4" FLEX HOSE to the DIVERTER and CENTURIONPRO



STEP 1
Attach BLOWER BAG to the BLOWER



Requires Cleaning
See Page 7

ELITE TRIMMING TECHNOLOGIES

FOR MORE INFORMATION ON OUR PRODUCT LINE PLEASE VISIT
WWW.CPROSOLUTIONS.COM



BLOWER CLEANING

For optimal performance and life, the BLOWER components must be cleaned every 3 to 4 days of use.

INSTRUCTIONS:

Clean with pressure washing at 1500-2000 PSI, Hot Water, Fan Spray setting. Run BLOWER for 15 minutes after washing, allowing components to dry. Avoid water contact on bearings.

STEP 1

Remove the COVER and IMPELLER from the BLOWER

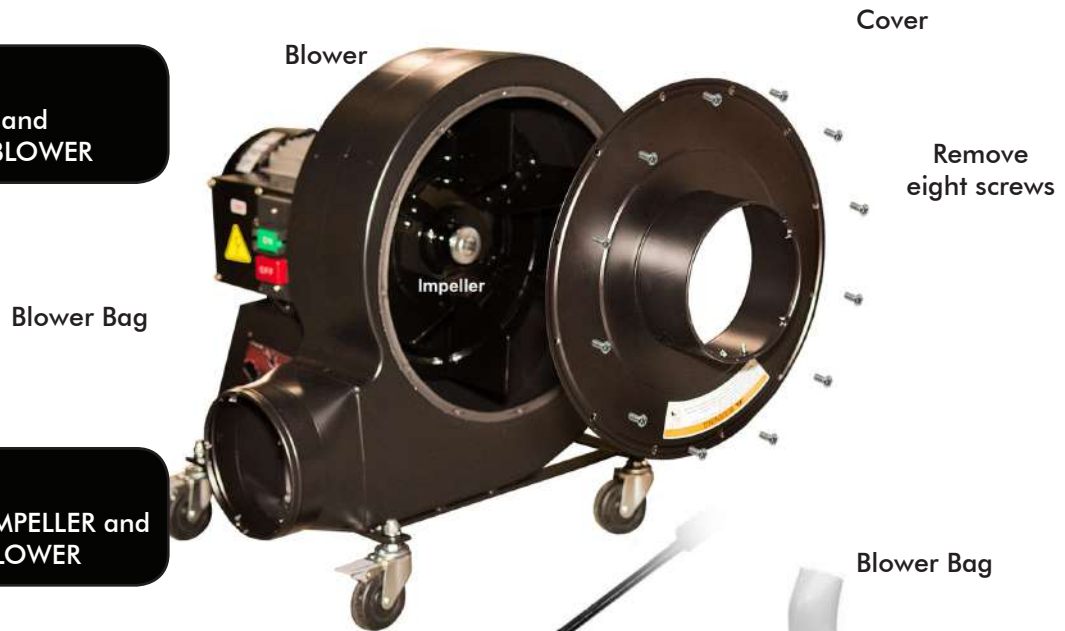

STEP 2

Pressure wash the IMPELLER and the interior of the BLOWER



ELITE TRIMMING TECHNOLOGIES

FOR MORE INFORMATION ON OUR PRODUCT LINE PLEASE VISIT
WWW.CPROSOLUTIONS.COM



HOPPER ASSEMBLY

STEP 1

Remove the COVER and IMPELLER from the BLOWER

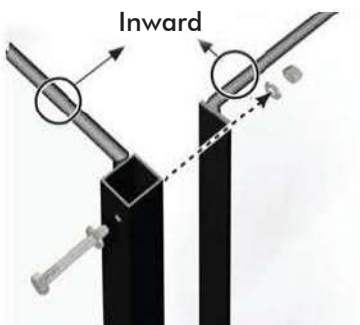

Inward

Hopper

STEP 2

Secure the HOPPER to the FRAME



Ensure the OPENING and FRAME (front) match

Opening

Frame (Back)

Ensure RODS are facing inward. Secure with 1/4" BOLTS, WASHERS & LOCKING NUTS

STEP 3

Locate the Hopper to the CenturionPro.

Ensure the Frame and OPENING match the CENTURIONPRO exactly.



Frame (Front)

ELITE TRIMMING TECHNOLOGIES

FOR MORE INFORMATION ON OUR PRODUCT LINE PLEASE VISIT

WWW.CPROSOLUTIONS.COM



WARRANTY INFORMATION

THE CENTURIONPRO MINI

MOTOR SERIAL NUMBER: _____

BLOWER SERIAL NUMBER: _____

DATE OF PURCHASE: _____

LOCATION OF PURCHASE: _____

STORE NAME (IF APPLICABLE): _____

EMAIL ADDRESS: _____

All information provided to CenturionPro Solutions Inc. will remain strictly confidential and will not be shared with third parties.

Thank you for your purchase

Please complete this page and email a copy to warranty@cprosolutions.com in order for the warranty to be valid.

If you require assistance, please contact our support line at 1-855-535-0558 or visit our website at www.cprosolutions.com

A 3 year warranty is included when purchasing Centurion Pro Machines. This warranty covers, the motor and any and all parts that are considered defective. The warranty does not cover neglect, abuse, physical damage, water damage, and/or operator error. Please take proper care of your machine.

ELITE TRIMMING TECHNOLOGIES

FOR MORE INFORMATION ON OUR PRODUCT LINE PLEASE VISIT
WWW.CPROSOLUTIONS.COM

MANUEL PROPRIÉTAIRES

THE CENTURIONPRO ORIGINAL



LES MEILLEURES TECHNOLOGIES D'EFFEUILLAGÉ

POUR DE PLUS AMPLES INFORMATIONS SUR NOS GAMMES DE PRODUITS, RENDEZ-VOUS À L'ADRESSE

WWW.CPROSOLUTIONS.COM





TABLE DES MATIERES

FRANCAIS

Montage de la machine.....	12
Retrait et nettoyage de la lame.....	13
Montage du couvercle.....	14
Montage de la Soufflerie.....	15
Nettoyage de la soufflerie.....	16
Montage de la Tremie.....	17
numeros de Serie.....	18

ELITE TECHNOLOGIES DE COMPENSATION

POUR PLUS D'INFORMATIONS SUR NOTRE GAMME DE PRODUITS S'IL VOUS PLAÎT VISITEZ

WWW.CPROSOLUTIONS.COM



▲ 110V

110V fonctionner seulement!

Etape 1

Soulevez le COUVERCLE

Couvercles

Brosse

Nettoyage necessaire
voir page 4

Huat de Cadre

Etape 2

Soulevez le HAUT DU CADRE

Desserrez les qua-
tre boulons 1/4"
et les rondelles



Etape 3

Soulevez le TAMBOUR

Tambour



Identifiez l'extremite la plus longue du
TAMBOUR lors de son remontage

Bague de caoutchouc

Lame et barre
du chassis

Nettoyage necessaire
voir page 4

Positionnement

Burette

Bobine de Coupe

Nettoyage necessaire
voir page 4

Moteur

Carenage

(zone situee derriere la bobine de coupe)

Nettoyage necessaire
voir page 4

Cadre

ELITE TECHNOLOGIES DE COMPENSATION

POUR PLUS D'INFORMATIONS SUR NOTRE GAMME DE PRODUITS S'IL VOUS PLAÎT VISITEZ

WWW.CPROSOLUTIONS.COM



Our leur assurer une duree de vie et des performances optimales, la lame et la barre du chassis doivent etre retirees et nettoyes toutes les quelques heures lors du fonctionnement de la machine.

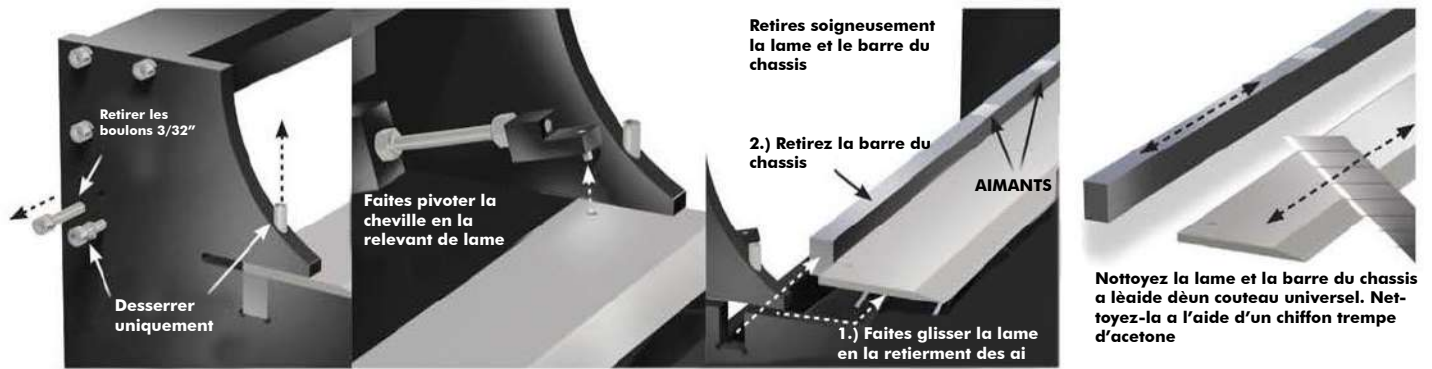

Pour l'installer, suivez l'order inverse du retrait

NETTOYAGE

Pour optimiser les performances et la duree de vie de la machine, le composants doivent etre nettoyes tous les 3 ou 4 jours d'ultisation

Instructions:

Nettoyez-le composant a l'aide d'un dispositif haute pression (de 10 a 130 bars) en utilisant de l'eau chaude pulverisee en eventail.

Fait ensuite fonctionner le CenturionPro pendant 15 minuts pour laisser secher ses composants.

Evitez que l'eua n'entre en contact avec les roulements.

Nettoyez l'ensemble de la bobine de coupe et du carnage pour retirer les debris

Nettoyez la brosse a l'eau pressurisee



ELITE TECHNOLOGIES DE COMPENSATION

POUR PLUS D'INFORMATIONS SUR NOTRE GAMME DE PRODUITS S'IL VOUS PLAÎT VISITEZ

WWW.CPROSOLUTIONS.COM



MONTAGE DU COUVERCLE

Il est dangereux d'utiliser le CenturionPro en l'absence de couvercle!

The Mini

Etape 1

fixez le couvercle de pignon sur le CenturionPro

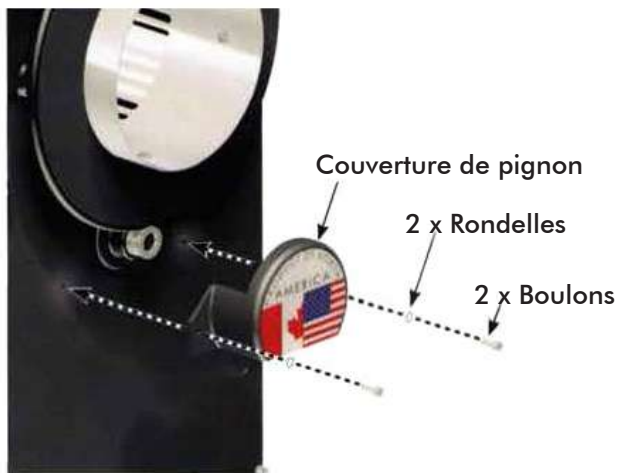

Etape 2

Fixez le revêtement cote tambour sur le CenturionPro

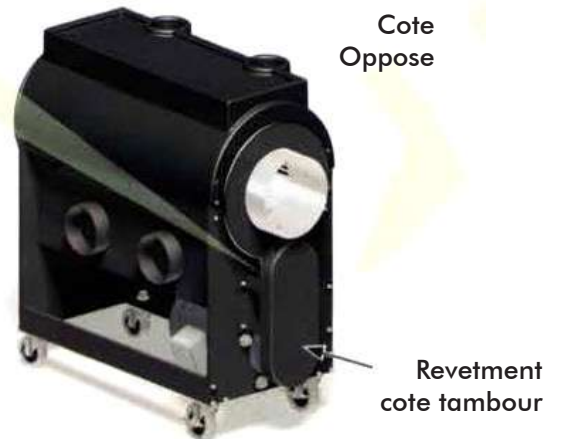
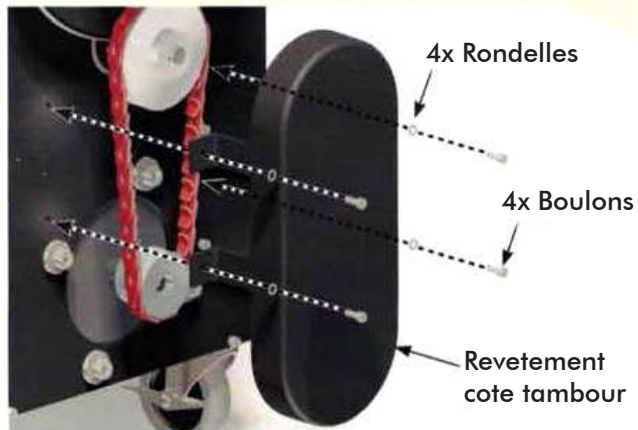

ELITE TECHNOLOGIES DE COMPENSATION

POUR PLUS D'INFORMATIONS SUR NOTRE GAMME DE PRODUITS S'IL VOUS PLAÎT VISITEZ

WWW.CPROSOLUTIONS.COM



MONTAGE DE LA SOUFFLERIE

⚠ 110V
110V fonctionner seulement!



Etape 2
Fixez le flexible 4" sure le deflecteur et le mini



Etape 1
Fixez le sac de la soufflerie sur la soufflerie



ELITE TECHNOLOGIES DE COMPENSATION

POUR PLUS D'INFORMATIONS SUR NOTRE GAMME DE PRODUITS S'IL VOUS PLAÎT VISITEZ

WWW.CPROSOLUTIONS.COM



NETTOYAGE DE LA SOUFFLERIE

Pour optimiser les performances et la durée de vie de la machine, les composants de la soufflerie doivent être nettoyés tous les 4 ou 4 jours d'utilisation.

INSTRUCTIONS:

Nettoyez la soufflerie à l'aide d'un dispositif haute pression (de 100 à 130 bars) en utilisant de l'eau chaude pulvérisée en entail. Faites-la ensuite fonctionner pendant 25 minutes pour laisser sécher les composants. Évitez que l'eau n'entre en contact avec les roulements.

Etape 1

Retirez le couvercle et la roue de la soufflerie

Blower Bag

Soufflerie

Couvercle

Retirez les 8 vis

Impeller

Etape 2

Nettoyez à haute pression la roue et l'intérieur de la soufflerie

Nettoyez l'intérieur de la soufflerie

Sac de la Soufflerie

Retournez le sac de la soufflerie à partir de la fermeture éclair puis faites-le sécher

Secouez-le énergiquement afin de retirer tous les débris

Inclinez la soufflerie pour permettre à l'eau d'être évacuée par l'ouverture

Retournez le sac à l'envers

Fermeture Eclair

ELITE TECHNOLOGIES DE COMPENSATION

POUR PLUS D'INFORMATIONS SUR NOTRE GAMME DE PRODUITS S'IL VOUS PLAÎT VISITEZ

WWW.CPROSOLUTIONS.COM



MONTAGE DE LA TREMIE

Etape 1

Assemblage du Cadre:

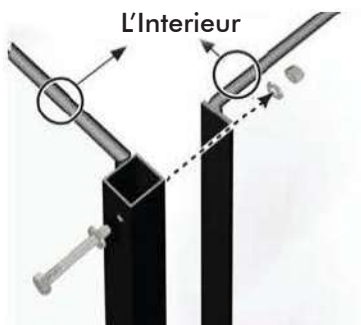

Ensure RODS are facing inward.
Secure with 1/4" BOLTS,
WASHERS & LOCKING NUTS

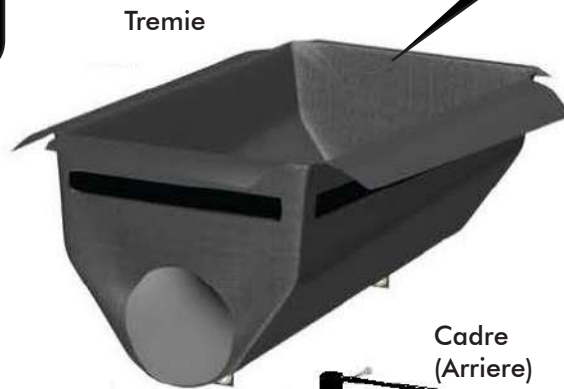

Ouverture

Cadre
(Arriere)

Cadre
(Avant)

Etape 2

Fixez la tremie sur le cadre



Alignez l'ouverture
et cadre (a l'avant)

Etape 3

Placez la tremie sur le
CenturionPro

Assurez-vous de bien aligner
le cadre et l'ouverture sur le
CenturionPro



ELITE TECHNOLOGIES DE COMPENSATION

POUR PLUS D'INFORMATIONS SUR NOTRE GAMME DE PRODUITS S'IL VOUS PLAÎT VISITEZ

WWW.CPROSOLUTIONS.COM



INFORMATIONS DE GARENTE

THE CENTURIONPRO MINI

NUMERO DE SERIE DU MOTEUR: _____

NUMERO DE SERIE DE LA SOUFFLERIE: _____

DATE D'ACHAT: _____

LIEU D'ACHAT: _____

NOM DE MAGASIN (LES CAS ECHEANT): _____

L'ADRESSE ELECTRONIQUE: _____

T Toutes les informations fournies A Centurion Pro Solutions Inc. Demeureront
Strictement confidentielles et ne seront pas divulguées a des tierces parties.

Merci pour votre achat

**Veillez renseigner cette page et l'envoyer par courrier electronique a l'adresse
warranty@cprosolutions.com afin de valider votre garantie.**

*Si vous avez besoin d'aide, veuillez contracter notre service d'assistance au 1-855-535-0558
ou visitez notre site web a l'adresse www.cprosolutions.com*

*Les machines Centurionpro disposent d'une garantie de 3 ans. Elle couvre la moteur ainsi que les pieces
jugees defectueuses. Cependant, cette garantie ne couvre pas les erreurs ni les abus de l'operateur. Veuillez
entretenir correctement votre machine.*

ELITE TECHNOLOGIES DE COMPENSATION

POUR PLUS D'INFORMATIONS SUR NOTRE GAMME DE PRODUITS S'IL VOUS PLAÎT VISITEZ

WWW.CPROSOLUTIONS.COM

MANUAL DEL PROPIETARIO

THE CENTURIONPRO ORIGINAL



TECNOLOGÍA DE CORTE

PARA MÁS INFORMACIÓN SOBRE NUESTRA LÍNEA DE PRODUCTOS, VISITE
WWW.CPROSOLUTIONS.COM





CONTENIDO

ESPAÑOL

Ensamblaje de maquinaria.....	21
Remoción y limpieza maquinaria.....	22
Montaje de la cubierta.....	23
Montaje del soplador.....	24
Limpieza del soplador.....	25
Montaje de la tolva.....	26
Números de serie.....	27

TECNOLOGÍA DE CORTE

PARA MÁS INFORMACIÓN SOBRE NUESTRA LÍNEA DE PRODUCTOS , VISITE

WWW.CPROSOLUTIONS.COM



▲ 110V
Operar a 110V solo!

PASO 1

Cubierta del elevador

PASO 2

Levante marco superior



Cubierta

Cepillo

Requiere Limpieza,
Consulte pagina 16

Marco Superior

PASO 3

Levante el Tambor

Tambor



Observe el extremo mas largo del tambor al volver a instalar

Anilla De Goma

Conjunto de Ajuste

Hoja u barra del lecho

Requiere Limpieza,
Consulte pagina 16

Chorro

Corte de Boninas

Requiere Limpieza,
Consulte pagina 16

Motor

Cubierta

(Area detras del corte de bobinas)

Requiere Limpieza,
Consulte pagina 16

Marco Inferior

TECNOLOGÍA DE CORTE

PARA MÁS INFORMACIÓN SOBRE NUESTRA LÍNEA DE PRODUCTOS, VISITE

WWW.CPROSOLUTIONS.COM



Para Obtener una vida y rendimiento optimo, la hoja y barra del lecho deben retirarse luego de limpiarse cada cierto numero de horas de funcionamiento.

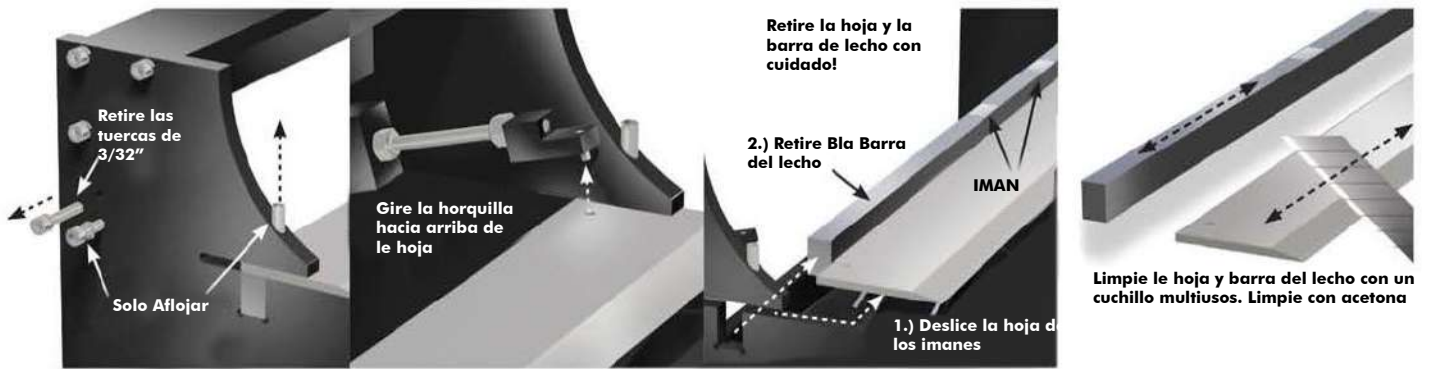

La instalacion es del orden inverso de la remacion

Limpieza

Para obtener una vida y rendimiento optimo, los componentes deben limpiars cada 3 a 4 de uso.

Instrucciones:

Limpiar con lavadora a presion a 1500-2000 psi, agua caliente, ajuste del rociador difuser del soplador.

Active el CenturionPro durante 15 minutos despues del lavado, permitiendolo que los componentes se sequen. Evite el contracto del agua directamente sobre los rodamientos.

Limpie el cupillo usando lavadora a presion.



Limpie la longitud del corte de bobinas y la cubierta de los residuos



TECNOLOGÍA DE CORTE

PARA MÁS INFORMACIÓN SOBRE NUESTRA LÍNEA DE PRODUCTOS , VISITE

WWW.CPROSOLUTIONS.COM



MONTAJE DE LA CUBIERTA

No es seguro operar el Mini sin cubiertas!

The Mini

PASO1

Anexe la cubierta del engranaje al Mini

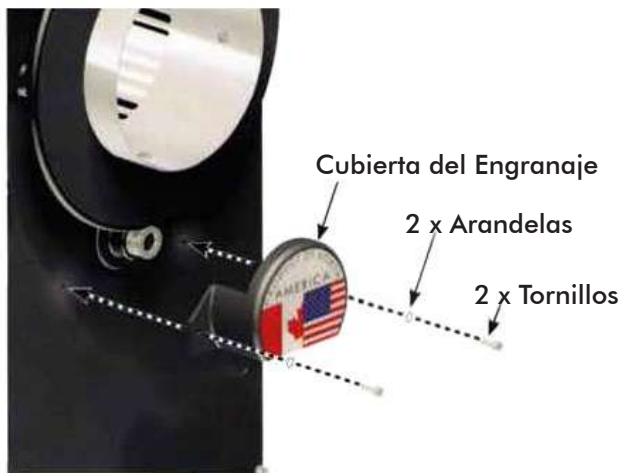

PASO2

Attach the BELT COVER to the CENTURIONPRO

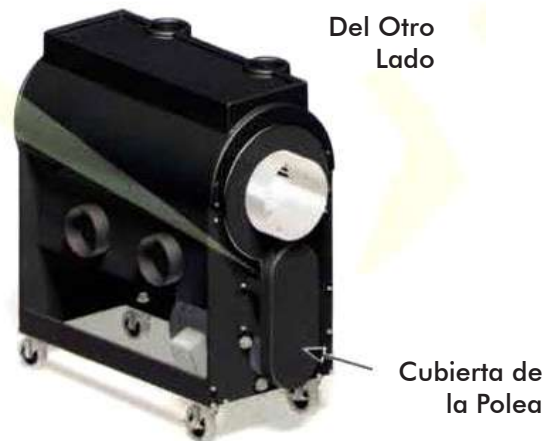
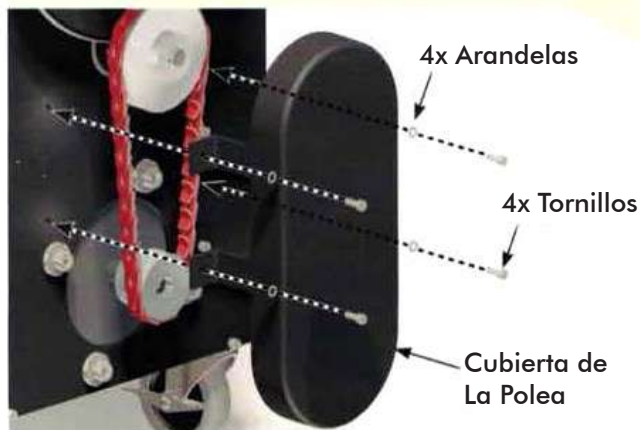

TECNOLOGÍA DE CORTE

PARA MÁS INFORMACIÓN SOBRE NUESTRA LÍNEA DE PRODUCTOS, VISITE

WWW.CPROSOLUTIONS.COM



MONTAJE DEL SOPLADOR

⚠ 110V
Operar a 110V solo!



PASO 2
Anexe manguera flexible de 4" a desviador y Mini



PASO 1
Anexe le bolsa del soplador



Requiere Limpieza,
Consulte pagina 7

TECNOLOGÍA DE CORTE

PARA MÁS INFORMACIÓN SOBRE NUESTRA LÍNEA DE PRODUCTOS , VISITE
WWW.CPROSOLUTIONS.COM



LIMPIEZA DEL SOPLADOR

For optimal performance and life, the BLOWER components must be cleaned every 3 to 4 days of use.

INSTRUCCIONES:

Limpié con lavadora a presión a 1500 - 2000 PISA, Auha caliente, ajuste el rociador diusor del soplador, active el SOPLADOR durante 25 minutos despues del lavado, permitiendo que los compionetes se sequen. Evite el contacto de audo dirtctamente sobre los rodamientos.

PASO 1

Quite la CUBIERTA y el MPULSOR del SOPLADOR

Bolsa del soplador

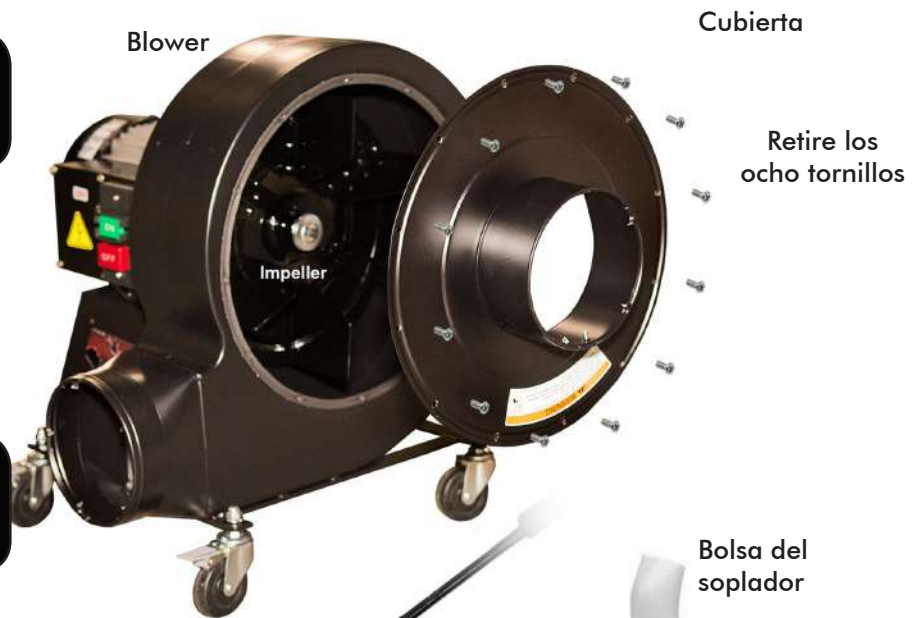

STEP 2

Presione para lavar el IMPULSOR y el interior del soplador

Limpié todo el interior del soplador

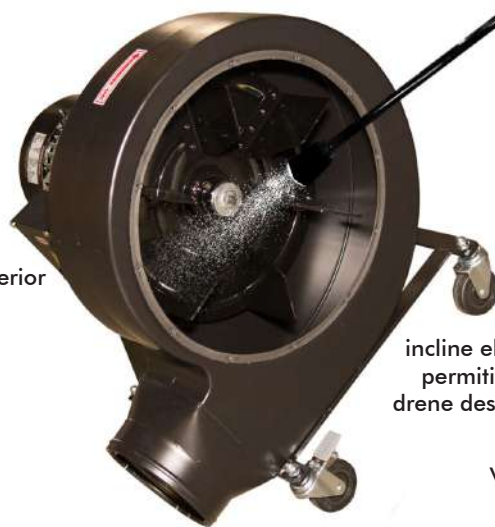

Bolsa del soplador

Ponga la BOLSA DEL SOPLADOR de Adentro hacia afuera de la CREMALLERA y deje secar

Agite vigorosamente de todos los residous

CREMALLERA

TECNOLOGÍA DE CORTE

PARA MÁS INFORMACIÓN SOBRE NUESTRA LÍNEA DE PRODUCTOS, VISITE

WWW.CPROSOLUTIONS.COM



MONTAJE DE LA TOLVA

PASO 1 MONTAJE DE MARCO

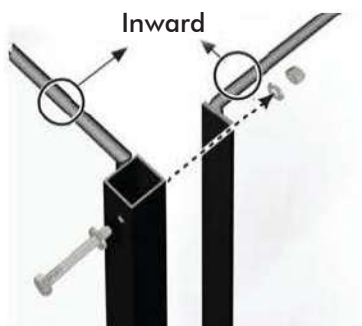

Asegure de que las varillas
están hacia adentro
Asegure con 1/4" pernos arandelas
y tuercas de seguridad

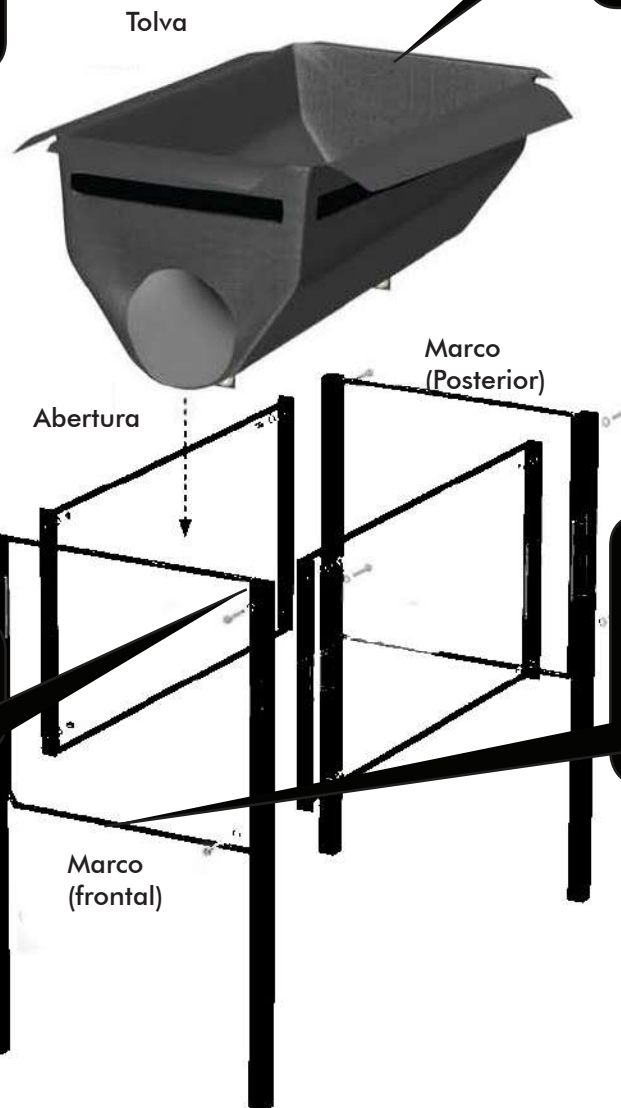

PASO 2 Asegure el bastidor en el marco



PASO 3 Coloque el bastidor en el CenturionPro

Asegure de que el marco y la
apertura coinciden con el CenturionPro
exactamente

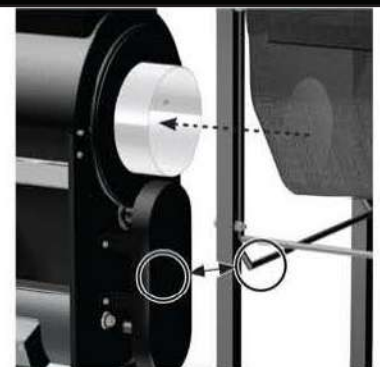

TECNOLOGÍA DE CORTE

PARA MÁS INFORMACIÓN SOBRE NUESTRA LÍNEA DE PRODUCTOS, VISITE
WWW.CPROSOLUTIONS.COM



INFORMACION DE GARANTIA

THE CENTURIONPRO MINI

NUMERO DE SERIE DE MOTOR: _____

NUMERO DE SERIE DE SOPLADOR: _____

FECHA DE COMPRA: _____

LUGAR DE COMPRA: _____

NOMBRE DE TIENDA (SI PROCEDE): _____

DIRECCION DE CORREO ELECTRONICO: _____

Toda la informacion proporcionada a CenturionPro Solutions Inc. Permanecera Estrictamente confidencial y no sera compartida con terceros.

Gracias por su compra

Por favor complete esta pagina y envíe una copia por correo electronica a warranty@cprosolutions.com para que la garantia para sea valida.

Si requiere ayuda por faor pngase en contacto con nuestra linea do apoya al 1-855-535-0558 o visite neustro sitio web en www.cprosolutions.com

Una garatia de anos se incluye comprando maquinas CenturionPro. Esta garantia cubre el motor y alguna todas las partes que son partes que son consideradas. La garantia, sin embargo, incluye el error del operador y/o el abuso. Por favor cude bien su maquina.

TECNOLOGÍA DE CORTE

PARA MÁS INFORMACIÓN SOBRE NUESTRA LÍNEA DE PRODUCTOS , VISITE

WWW.CPROSOLUTIONS.COM