



sun-huts.com

INSTRUCTIONS

Models 20 • 35 • 50 • 70 • 100 • 160

Part Numbers: Model 20 #706290 Model 70 #706296
 Model 35 #706292 Model 100 #706298
 Model 50 #706294 Model 160 #706300

POLE SIZES

Model 20	
Wall Poles	30.5" 775mm
Floor & Ceiling Poles	21.6" 550mm
Assembled Size: 2'W x 2'D x 5.3'H	
Model 35	
Wall Poles	30.5" 775mm
Floor & Ceiling Poles	29.5" 750mm
Assembled Size: 2.6'W x 2.6'D x 5.3'H	
Model 50	
Wall Poles	34.4" 875mm
Floor & Ceiling Poles	32.5" 825mm
Assembled Size: 3'W x 3'D x 5.9'H	
Model 70	
Wall Poles	38.4" 975mm
Floor & Ceiling Poles	37.4" 950mm
Assembled Size: 3.3'W x 3.3'D x 6.6'H	
Model 100	
Wall Poles	38.4" 975mm
Floor & Ceiling Poles	45.3" 1150mm
Assembled Size: 3.9'W x 3.9'D x 6.6'H	
Model 160	
Wall Poles	38.4" 975mm
Floor & Ceiling Poles	45.3" 1450mm
Assembled Size: 4.9'W x 4.9'D x 6.6'H	

BEFORE YOU BEGIN:

Make sure you have a clear, unobstructed area to work in. Lay out all poles and connectors, grouped according to their size and/or shape. **2 PEOPLE are recommended to safely lift and fit tent body over assembled frame (Models 70, 100 and 160).**



2 PEOPLE Recommended for Assembly

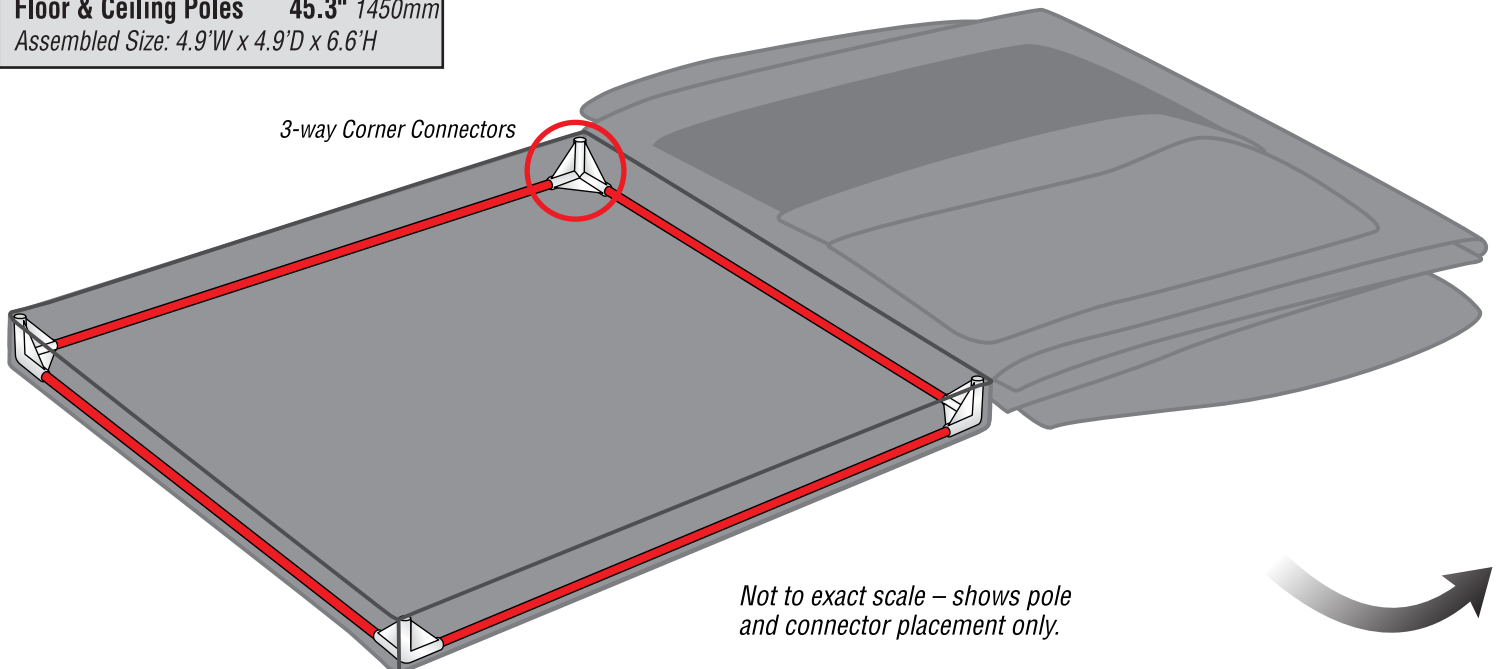
(Models 70, 100 and 160)

PARTS LIST

- 11** Floor & Ceiling Poles (all models)
- 8** Wall Poles (all models)
- 4** Straight Pole Connectors
- 8** 3-way Corner Connectors
- 6** Equipment Hanger Connectors
- 1** Window Cover
- 2** Vent Covers
- 2** Equipment Straps
- 1** Removable Mylar Floor Insert

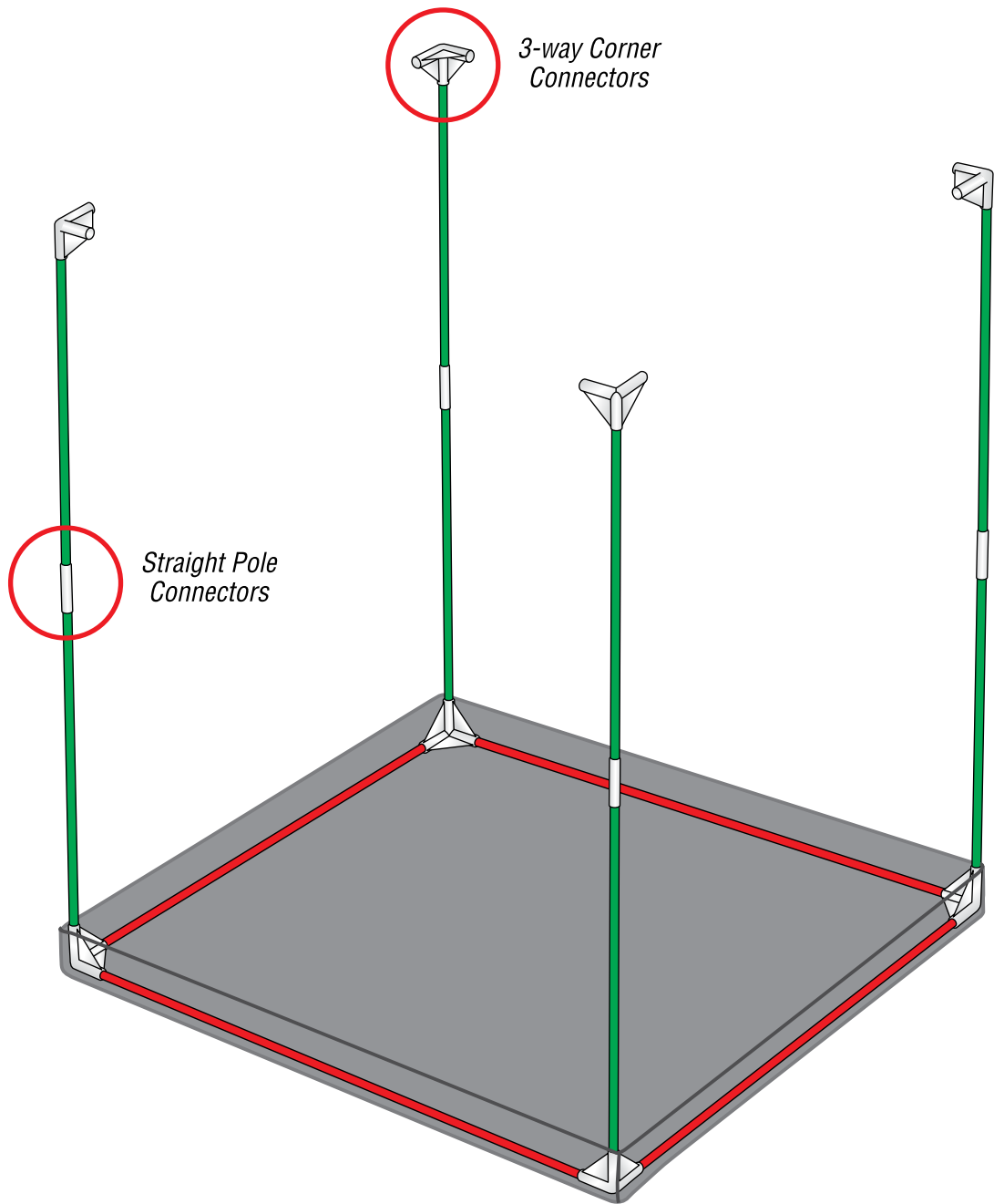
STEP 1

Lay out tent body, unzip all doors, then fully expose floor tray and smooth it flat. Start frame assembly with floor poles first, inside floor tray as shown.



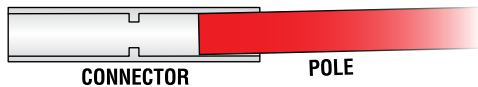
Not to exact scale – shows pole and connector placement only.

STEP 2 Add wall poles and 3-way Corner Connectors at top.



IMPORTANT! Make sure all poles are fully inserted into connectors.

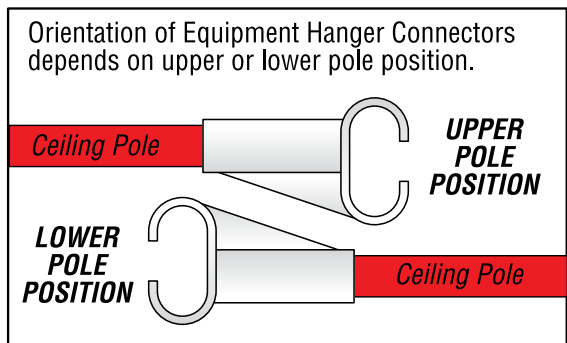
WRONG



RIGHT

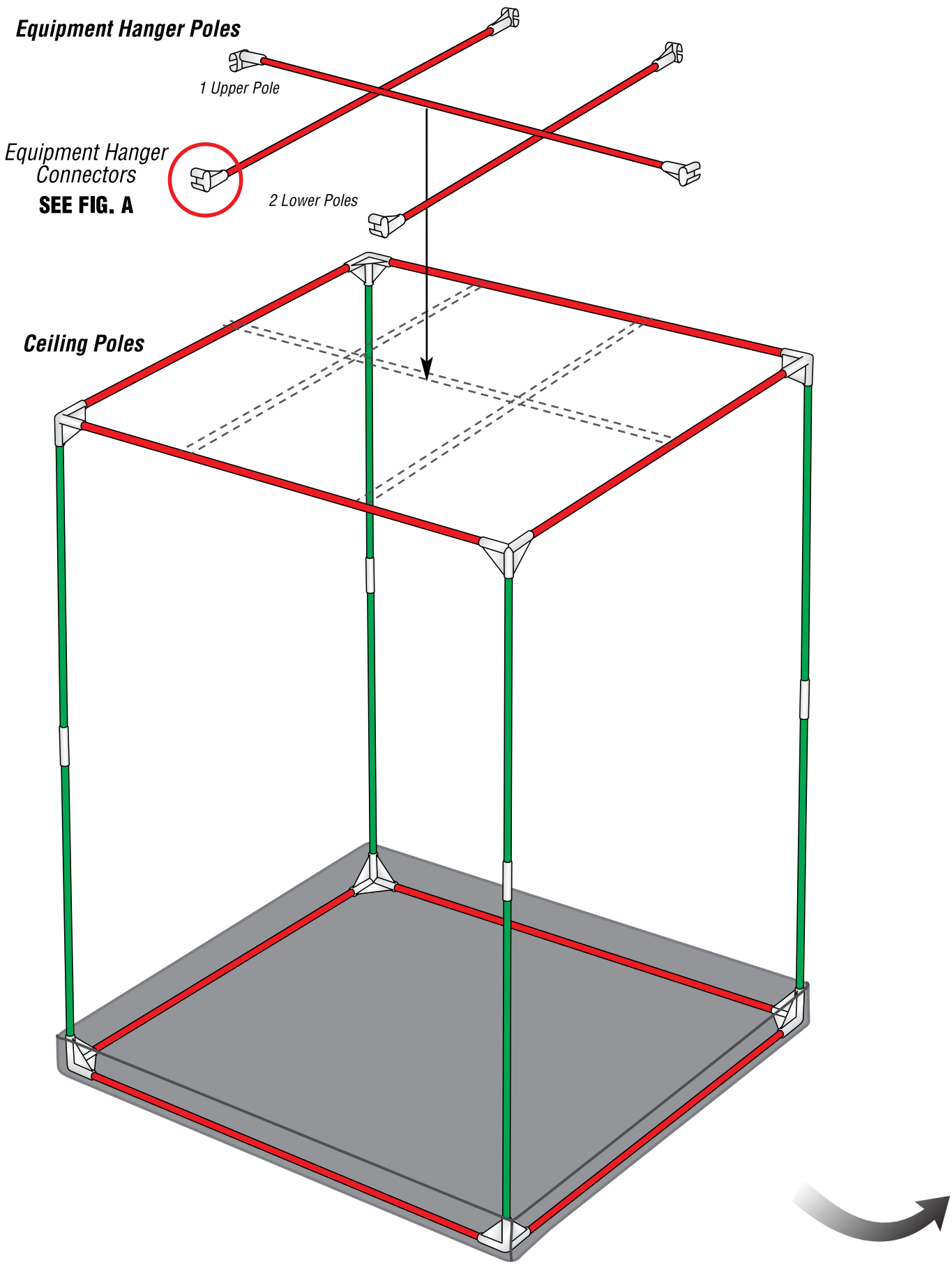


Fig. A



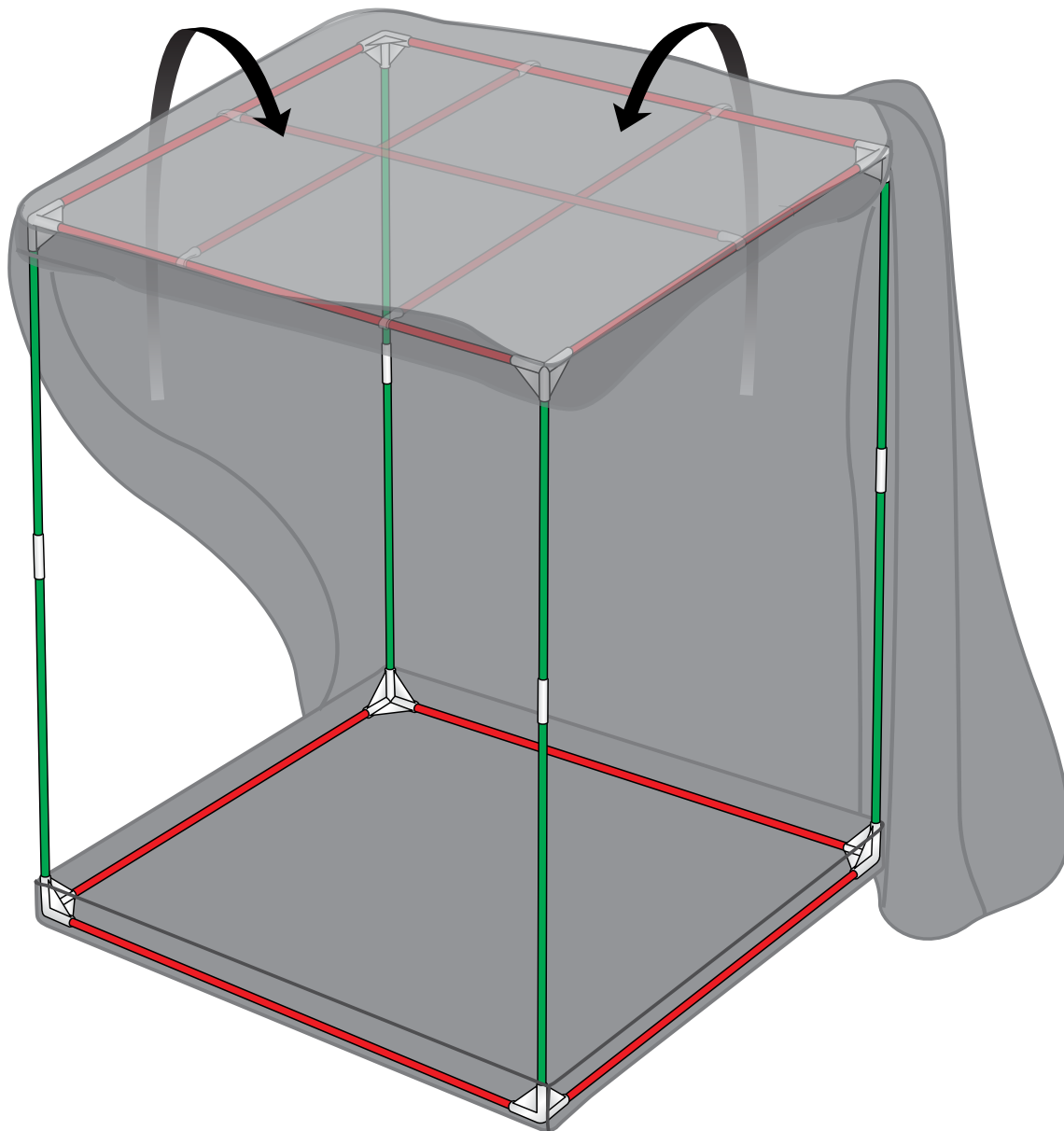
STEP 3

Assemble Ceiling Poles and Equipment Hanger Poles.



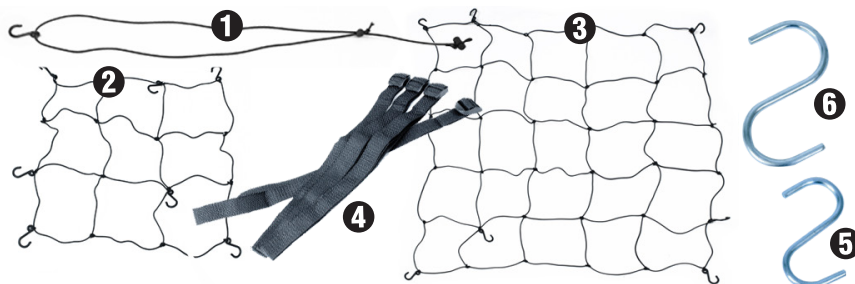
STEP 4

Carefully lift tent body and fit over completely assembled frame (2 people are recommended for this job on Models 70, 100 and 160 – 1 person attempting to force the tent body over the frame could cause damage). After tent body is evenly placed, zip doors closed and make final adjustments to fit. Move equipment in and start growing!



OPTIONAL ACCESSORIES

1. #706590 Elastic Support (4/pack)
2. #706592 2' x 3.33' Elastic Trellis (1/pack)
3. #706594 4' x 5' Elastic Trellis (1/pack)
4. #706596 Support Strap (2/pack)
5. #706598 16mm S Hook (5/pack)
6. #706600 22mm S Hook (5/pack)



FRAME ASSEMBLY DIAGRAM

Not to exact scale – to show pole and connector placement only.

8 38.4" Wall Poles
975mm

11 45.3" Floor & Ceiling Poles
1150mm

SUN HUT
Black Out
MODEL 100
Product #706298
Assembled Size: 3.9'W x 3.9'D x 6.6'H

