

ADVANCE[®]
Pocket Guide to
High Intensity
Discharge Lamp
Ballasts

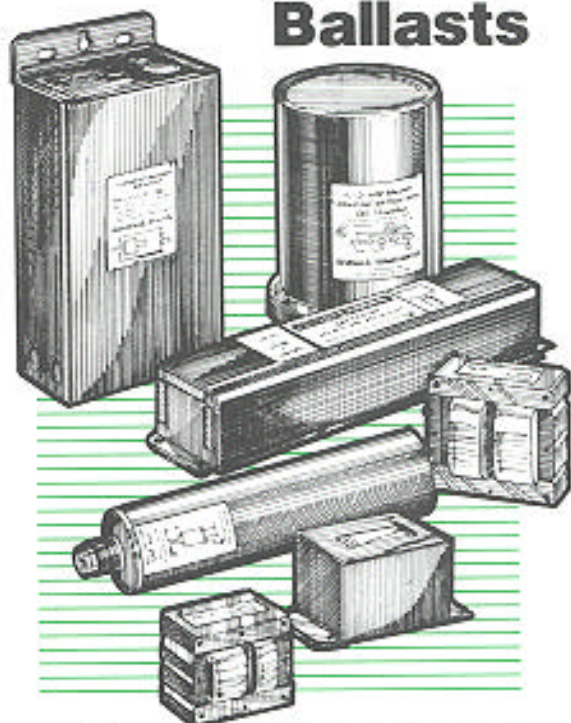

ADVANCE
TRANSFORMER CO.

**Prepared by the
Product Administration Group
Technical Services Dept.
Advance Transformer Co.**

The High Intensity Discharge (HID) lighting industry has experienced tremendous growth in terms of size, as well as complexity. The search for more efficient sources of illumination for an endless variety of applications continues to result in a wide variety of lamp types, of various wattages and efficiencies.

These new lamps have also yielded many different shapes and sizes of the ballasts, which are required for lamp operation.

By acquainting you with some of the basic mechanical and electrical characteristics of HID lamp ballasts, we hope to simplify the task of selecting the optimum ballast for any given HID lighting system. Also, by offering a procedure to facilitate recognition of possible lighting system operating faults, we hope to simplify corrective maintenance procedures.

This booklet attempts to be as general in nature as possible in discussing ballasts. However, because it has been prepared by the technical staff of Advance Transformer Co., it tends to reflect primarily the ADVANCE⁰ HID Ballast Line due to a greater familiarity with its scope, design and operating characteristics.

NOTE: The information contained in this handbook is based on our experience to date and is believed to be reliable. It is intended as a guide for use by persons having technical skill at their own discretion and risk. We do not guarantee favorable results or assume any liability in connection with its use. This information is *not* intended to conflict with existing codes, ordinances and regulations. These should be observed at all times.

PRICE \$2.00 each

©ADVANCE TRANSFORMER CO. 1998

Printed in U.S.A.

CONTENTS

	Page
HID LAMPS	3-7
Operating Characteristics	3
Lamp Starting	4-5
Lamp Efficiencies	5-7
BALLASTS	8-16
Design Applications	8-13
Input Voltages	14
Distributor Packs	15
Standby Lighting Systems	16
BALLAST CIRCUITRY	17-30
Lamp Regulation Characteristics	18
Mercury, Metal Halide & Low Pressure Sodium Lamps	19-22
High Pressure Sodium Lamps	28
Alternate Terminology	29
Ballast Circuitry Characteristics Comparison	30
BALLAST-TO-LAMP REMOTE MOUNTING DISTANCES	31-34
CAPACITORS	35-39
Oil Filled Type	35-36
Proper Wiring	36-37
Dry Metalized Film Type	38
Capacitor Failure Modes	39
IGNITORS	40-43
TROUBLESHOOTING	44-66
Visual Inspection Check Lists	45-46
Quick Fix for Restoring Lighting	47
Troubleshooting Flow Charts	48-52
Electrical Tests	53-66
Line Voltage	54
Open Circuit Voltage	55-57
Capacitor Check	58
Ballast Continuity Check	59-60
Short Circuit Lamp Current	60-63
HPS Ignitors	64-65
Further Checks	66

**World's Largest
H.I.D. Lamp Ballast
Manufacturing
Facility**



**Advance Transformer Co.,
Boscobel, Wisconsin**



FOREWORD

OPERATING CHARACTERISTICS

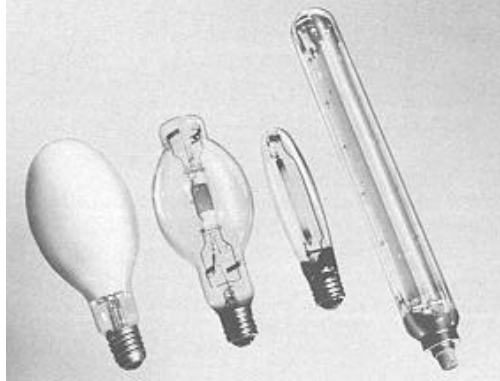

High Intensity Discharge Lamps (from left) Mercury, Metal Halide, High Pressure Sodium and Low Pressure Sodium.

Advance HID lamp ballasts are available to operate a wide variety of Mercury, Metal Halide, High Pressure Sodium and Low Pressure Sodium lamps available in today's marketplace.

All are electric discharge lamps. Light is produced by an arc discharge between two electrodes located at opposite ends of an arc tube within the lamp.

The purpose of the ballast is to provide the proper starting and operating voltage and current to initiate and sustain this arc.

HID LAMPS

LAMP STARTING

Mercury and Metal Halide Lamps

Mercury and most Metal Halide lamps have an additional electrode located at one end of the arc tube to assist in lamp starting. These types of lamps require an open circuit Voltage (O.C.V.) approximately two times the lamp voltage to initiate and sustain the arc.

High Pressure Sodium Lamps

High Pressure Sodium and some of the newer Metal Halide lamps, however, have no starting electrodes. In addition to an O.C.V. of approximately two times the lamp voltage, these lamps are started by a high voltage starting pulse, provided by an ignitor, applied across the arc tube.

Low Pressure Sodium Lamps

Because they have neither a starting electrode or an ignitor, Low Pressure Sodium Lamps require an open circuit voltage of approximately three to seven times the lamp voltage to start and sustain the lamp.

LAMP OPERATION

Electric discharge lamps have a negative resistance characteristic, which would cause them to draw excessive current leading to instant lamp destruction if operated directly from this voltage. The ballast is therefore utilized to limit this current to the correct level for proper operation of the lamp.

HID lamps will take several minutes to warm up and reach full lumen output. An interruption in the power supply, or a sudden voltage may cause the arc to extinguish. A lamp that is still hot will not restart immediately.

HID LAMPS

Before the lamp will relight, it must cool sufficiently to reduce the vapor pressure within the arc tube to a point where the arc will restrike. The approximate warm-up and restriking times of the HID lamp groups are as follows:

LIGHT SOURCE	WARM-UP TIME	RESTRIKE TIME
Mercury Vapor	5-7 minutes	3-6 minutes
Metal Halide	2-5 minutes	10-20 minutes
High Pressure Sodium	3-4 minutes	½-1 minute
Low Pressure Sodium	7-10 minutes	3-12 seconds

LAMP EFFICIENCIES

The many available HID light sources provide the lighting operator with a selection of viable alternatives for any specific lighting installation. However, each has its own characteristics, which must be individually considered for any given lighting application:

- Lumen Output
- Color Rendition
- System Efficacy
- Lumen Maintenance

Additionally, with today's rapidly increasing energy costs, energy cost savings is an important consideration in all lighting source evaluations. A direct, lumens-per-watt comparison of the four sources is included on the following page for your reference. Light sources which supply greater lumens-per-watt will also provide a greater amount of light per energy dollar.

HID LAMPS

COMPARISON of LAMP EFFICIENCIES

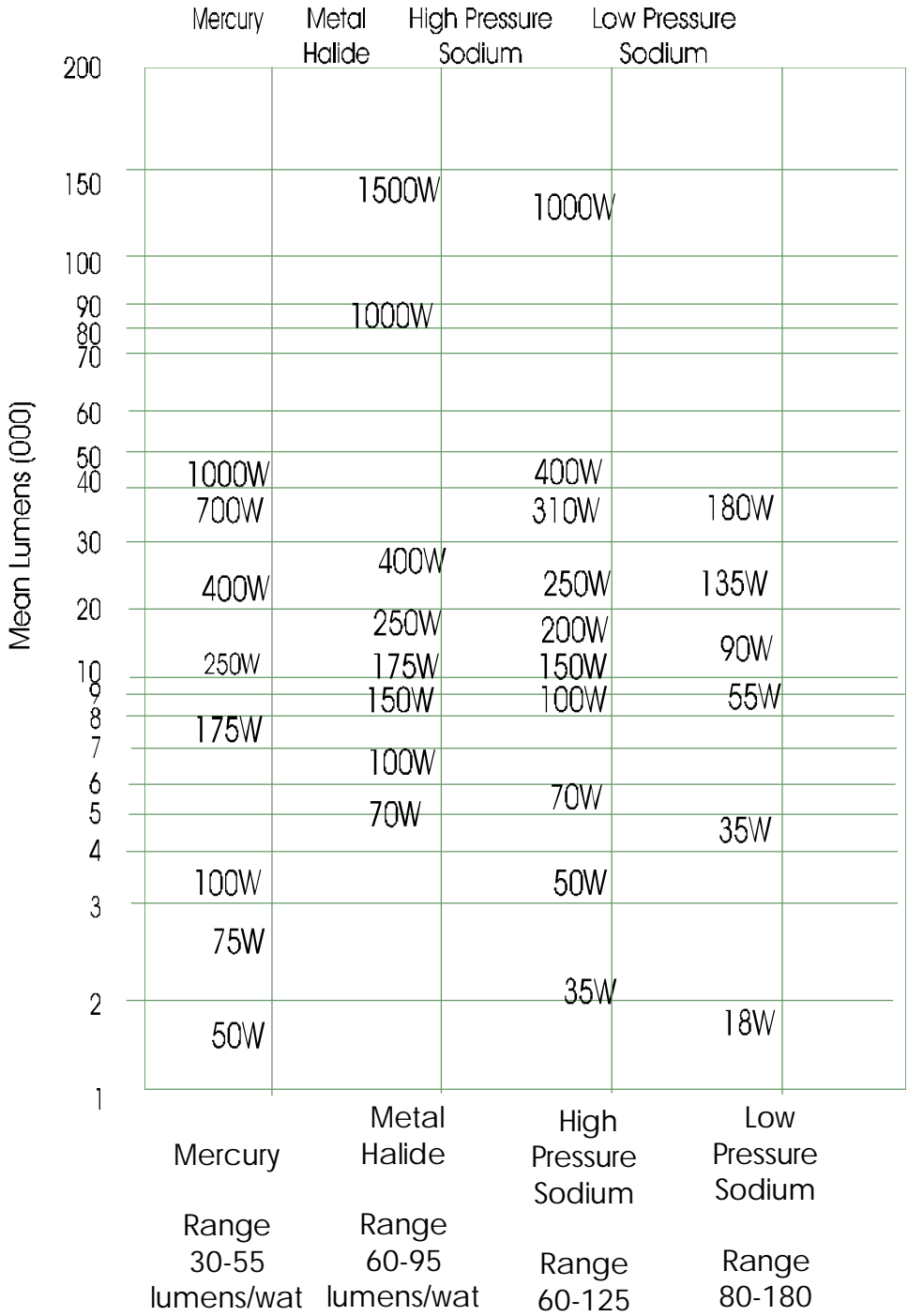

THIS PAGE INTENTIONALLY LEFT BLANK

BALLASTS

BALLAST DESIGN APPLICATIONS

HID lamp ballasts are available in a variety of shapes and sizes for the most popular lighting applications. Six basic designs are in widest use today.

Core & Coil

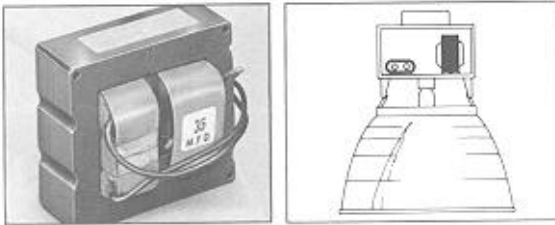

The most basic of all shapes is the core & coil which may also be used by itself as a component of a fixture, but is also used to form the nucleus to the five other ballast configurations detailed in this section. It consists of one, two or three copper coils on a core (or "stack") of electrical grade steel laminations. As shown here, the core & coil ballast will be mounted within a fixture housing by the luminaire manufacturer. It represents today's most popular method of utilizing a ballast.

The core & coil ballast may be mounted in the luminaire by utilizing the mounting holes which run through the laminations, or through holes in a mounting bracket, which is welded to the ballast. For ballast replacement applications, industry standard ballast replacement kits are available which include capacitor and ignitor (where required) and a complete set of bolt-on mounting brackets with screws and nuts which are used when needed.

BALLASTS

In spite of the variety of HID lamps in use, and the greater variety of electrical characteristics which are required, today's standard ADVANCE core & coil ballast line has been designed around only four basic sizes. This allows the fixture manufacturer the benefits of standardization: the lighting operator a simplified replacement task, if necessary; and the electrical distributor the advantages of providing immediate availability from a minimal stock.

Potted Core & Coil

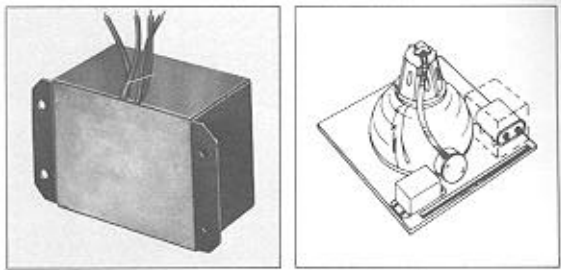

For indoor applications of HID lighting fixtures, such as in offices, schools and retail stores, ballast noise must be minimized. For these uses, standard ADVANCE core & coil ballasts are encased and potted in a high-temperature resin (Class H, 180°C max.) and secured to the fixture through integral mounting flanges on the ends of the case. As with the basic core & coil, the capacitor (and ignitor of HPS lighting) must also be mounted separately in the fixture.

F-Can

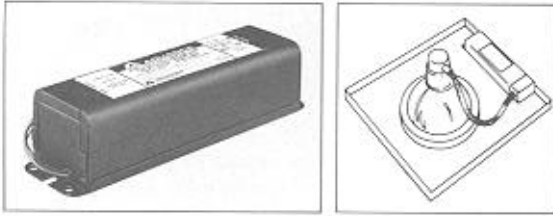

Also designed for indoor applications, these ballasts are encased and potted in Fluorescent ballast type cans and utilize Class A (90°C max.) insulating materials (the same as used in fluorescent lamp ballasts) for normal indoor ambients. This insulation is primarily used to minimize inherent ballast noise.

The Advance line is designed for dual use, with both 120 and 277 volt inputs. Each unit has a built-in automatically resetting thermal protector, which disconnects the ballast from the power line in the event of overheating. All high power factor units include capacitors within the can. All models for High Pressure Sodium and low-wattage Metal Halide lighting applications also include an integral ignitor.

BALLASTS

Indoor Enclosed

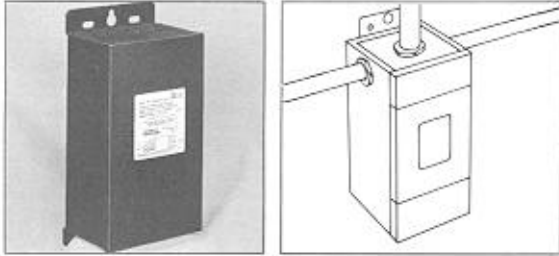

These units are designed for use indoors where the ballast must be mounted remotely from the luminaire. They are most typically used in factories where the luminaire may be mounted in a high bay where high ambient temperatures may be experienced. In these instances the remotely mounted ballast operates cooler, providing subsequent longer life.

The case contains the core & coil encased and potted in heat dissipating resin (Class H, 180°C max.) within the ballast compartment. Knockouts in both ends of the case facilitate hook-up in the most convenient manner. Wall mounting is accomplished through flanges on the top and bottom of the case. The capacitor and ignitor (where used) are also included in the case.

BALLASTS

Outdoor Weatherproof

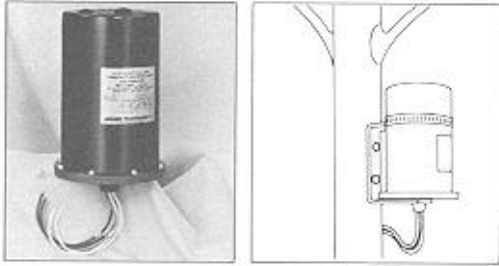

Weatherproof ballasts are designed for remote, pole-top mounting outdoors under all weather conditions. They may also be placed inside a transformer pole base, but care must be taken to avoid flood situations because weatherproof ballasts are not water submersible.

A core & coil, with capacitor and ignitor (where required) are firmly mounted to the heat-sink base. This assembly is then protected with an aluminum cover, which is gasketed and bolted to the base. Except for the very largest size or rating, Advance units contain no fill compound. These lightweight units provide ease of installation. The weather-resistant gasket between the hydroformed cover and die-case base affords maximum protection. An integral 1" NPT threaded nipple with locknut on the base facilitates hook-up to the mounting bracket when used on pole-top. This unit may also be placed nipple-up, with a drip loop, inside a pole base.

BALLASTS

Post Line

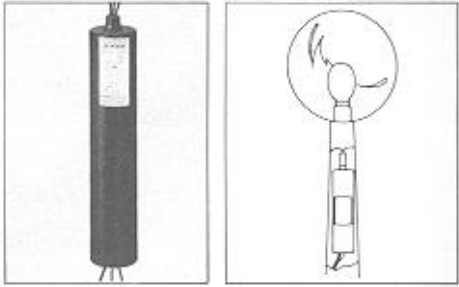

Lantern type fixtures mounted on slender poles require ballasts, which fit into the poles. Special, elongated core & coils are encased and potted in high temperature resin (Class H, 180°C max.) in cylindrical cans having a 2 9/16" outside diameter so they can be placed within all poles having a greater inside diameter. All include the leads necessary for direct connection to a photocell.

Capacitor and ignitor (where required) are included within this can. A 1/2" NPT threaded nipple is used for vertical mounting, and leads extend from both ends of the can for ease of installation. To help prevent overheating, one to three feet of air space should be allowed in the pole above the ballast and the ballast should be positioned against the post interior wall to provide a heat-sink.

BALLASTS

BALLAST INPUT VOLTAGES



ADVANCE® Quadri-Volt ballast with choice of four input voltages.

Today's most widely used nominal input voltages for HID lighting systems include 120, 208, 240, 277 and 480 volts, with 120 and 277 the most popular. Advance ballasts are therefore designed to operate the wide variety of HID lamps at these inputs.

While models are generally available which operate at only a single input voltage, ADVANCE replacement ballast kits are also furnished as 120/277 Dual-Volt, and as a 120/208/240/277 Quadri-Volt. These more versatile designs are widely used in replacement applications.

Ballast, capacitor and ignitor identification information, as well as complete electrical specification data and circuit wiring diagrams are included on each ballast label as shown:

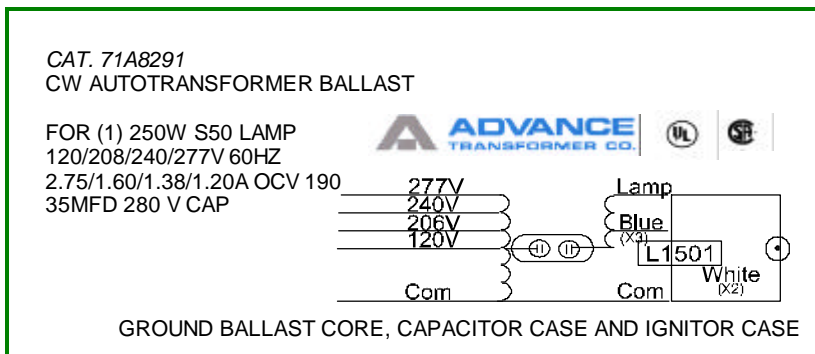

BALLASTS

DISTRIBUTOR PACKS

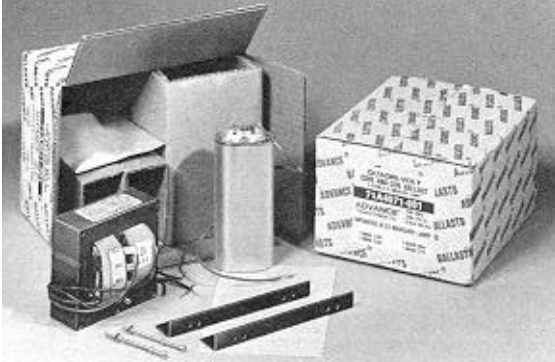

Convenient individual packs for Core & Coil ballasts

As an example, Advance furnishes Quadri-Volt Core & Coil Ballasts which can accommodate 120, 208, 140 and 277 volt inputs, along with the appropriate capacitor, ignitor (where required), mounting bracket, hardware and installation instructions in a space-saving carton for replacement applications. These Distributor Packs eliminate the need for distributors to stock ballasts with single input voltages.

Although the most popular Quadri-Volt Core & Coil Ballasts are furnished with for ¼" tab terminals and a single lead for connection to the appropriate tab, models are also available with four individual leads where the three unused leads must be insulated prior to operation.

BALLASTS

STANDBY LIGHTING SYSTEMS



Quadri-Volt ballasts are also ideal for applications where an incandescent lamp is incorporated in the fixture. This provides immediate standby lighting in the event power is momentarily lost, extinguishing the HID lamp, which then must go through its restrike phase. The 120 volt tap can be connected, via a relay, to power a 120-volt incandescent lamp until the HID lamp has cooled sufficiently to restrike.

BALLAST CIRCUITRY

GENERAL

The ballast in an HID lighting system has generally two purposes: 1) to provide the proper starting voltage to strike and maintain the arc; and 2) to provide the proper current to the lamp once the arc is established.

In addition to being designed to operate a particular type of HID lamp, a ballast design incorporates a basic circuitry to provide specific lamp/ballast operating characteristics. As an example, the effects of line voltage variations on resultant changes of lamp wattage are a function of the ballast circuit design. Requirements for a circuit which will provide a finer degree of lamp regulation generally result in a higher ballast cost.

For some types of lighting applications a particular ballast circuit has already been proven most cost effective and is, therefore, the only circuit offered. For others, a ballast with optimum circuitry for the particular application must be selected from the two or three alternatives that are available.

BALLAST CIRCUITRY

LAMP REGULATION CHARACTERISTICS

One of the most important characteristics of each particular ballast circuit is the degree to which it controls the lamp wattage (light output) when the input line voltage changes. The following chart compares the relationship of the three basic circuits as the input volts are changed.

As an example, the CWA line indicates that at 90% of line voltage, the ballast will operate the lamp at 95% of its nominal wattage. Similarly, at 110% of line voltage, the ballast will operate the lamp at 105% of nominal wattage.

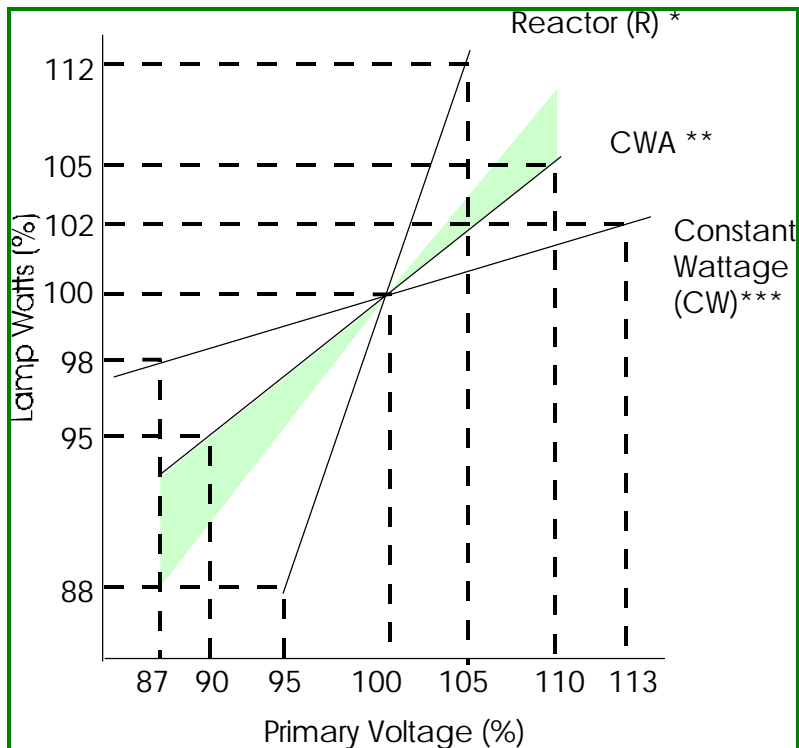

*Reactor and High Reactance = R and HX Mercury, Metal Halide and High Pressure Sodium lamp ballasts.

** Constant Wattage Autotransformer = CWA Mercury. Similar to regulation of CWA Metal Halide and High Pressure Sodium lamp ballasts.

*** Constant Wattage and Regulated Lag = Premium CW Mercury and REG LAG High Pressure Sodium lamp ballasts.

BALLAST CIRCUITRY

CIRCUIT TYPES FOR MERCURY, METAL HALIDE & LOW PRESSURE SODIUM LAMPS

Reactor ®

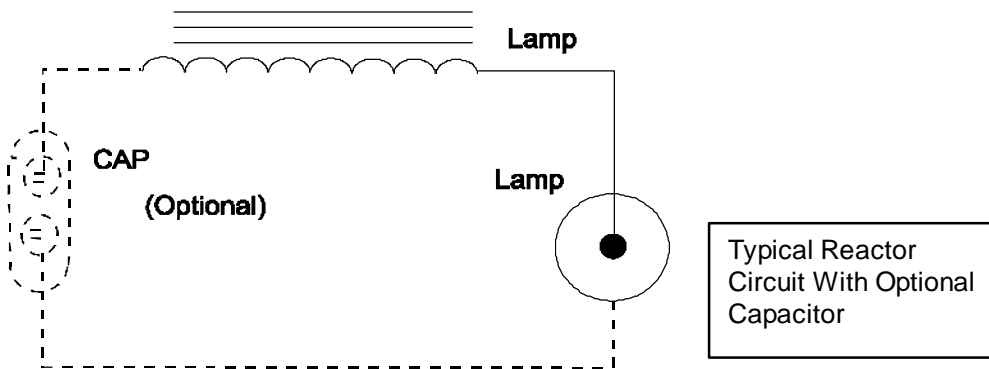

When the input voltage to a fixture meets the starting voltage of an HID lamp, a reactor ballast may be employed to operate the lamp. The necessary lamp starting voltage comes from the input voltage to the ballast. Because most Mercury lamps are designed to start at 240 or 277 volts, the reactor ballast is the most economical way to ballast a Mercury lamp in systems operated at either of these two input voltages.

Both reactor and high reactance ballasts (described in the following section) provide the same degree of lamp wattage regulation. They are inherently normal power factor devices (50%).

With these ballasts the input line voltage should be controlled to within $\pm 5\%$ because the resultant lamp wattage will vary $\pm 12\%$. However, this fair degree of lamp regulation is acceptable in many applications. In addition, in the event of a momentary power drop where the line voltage dips below 75% (e.g. to 180 volts on a 240 volt system), the HID lamp may extinguish.

BALLAST CIRCUITRY

Where necessary to reduce the current draw, a capacitor may be utilized across the input terminals to provide higher power factor (90%) operation. However, the addition of this capacitor will not change the ballast's lamp regulation characteristics. Additionally, because a reactor ballast draws substantially higher current during warm-up and/or open-circuit operation, the power distribution system must provide ample line capacity for this condition. As a result, there are fewer fixtures per circuit with reactor ballasts.

High Reactance Autotransformer (HX)

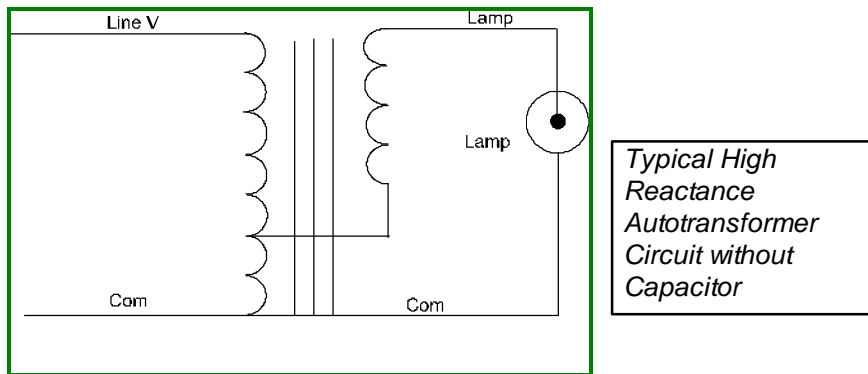

When the input voltage does not meet the starting voltage requirements of the HID lamp, such as 120, 208, or 480 volts for Mercury Vapor, a high reactance autotransformer ballast can be used to ballast the lamp. This will provide operating characteristics equal to the reactor.

The ballast, in addition to limiting the current to the lamp, transforms the input voltage to the required level. The ballast employs two coils, primary and secondary. It is called an autotransformer because the primary and secondary share common windings.

BALLAST CIRCUITRY

Also, like the reactor ballast, the autotransformer is inherently normal power factor (50%), but it may be corrected to high power factor (90%) with the addition of a capacitor across the input.

Its current draw and ability to withstand voltage dips are similar to that of the reactor.

Constant Wattage Autotransformer (CWA)

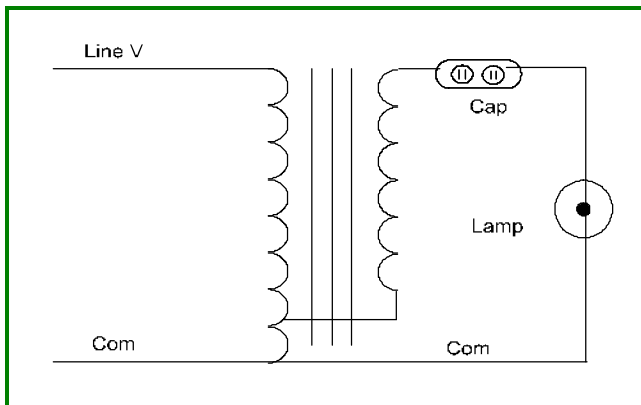

*Typical Constant
Wattage
Autotransformer
Circuit*

This is the most commonly used circuit because it offers the best compromise between cost and performance. It is a high power factor device, utilizing a capacitor in series with the lamp. A $\pm 10\%$ line voltage variation will result in a $\pm 5\%$ change in lamp wattage for Mercury, or $\pm 10\%$ change in wattage for Metal Halide. These regulation characteristics are greatly improved over the reactor and the high reactance circuits.

Additionally, the ballast input current during lamp warm-up does not exceed the current when the lamp is stabilized. The incidences of accidental lamp outages due to voltage dips is also greatly reduced because a CWA ballast can tolerate drops in line voltage of 30-40% before the lamp extinguishes (lamp dropout).

BALLAST CIRCUITRY

Constant Wattage (CW)

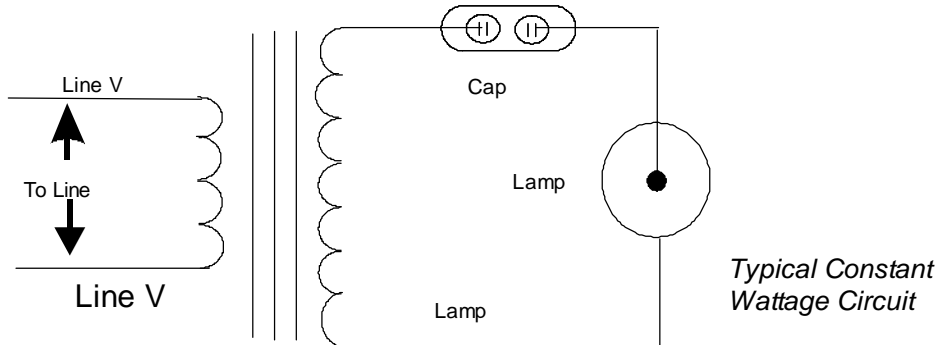

Sometimes referred to as premium constant wattage, this type of ballast will provide the highest lamp regulation available. Because there is no connection between the primary and secondary coils, this isolated circuit provides a safety factor against the danger of shock hazard.

Constant wattage ballasts are used with Mercury Vapor lamps and will accommodate a $\pm 13\%$ change in line voltage while yielding only a $\pm 2\%$ change in lamp watts. Incorporating a capacitor in series with the lamp, they are inherently high power factor, and their low input current at lamp start-up does not exceed their operating current. These units can tolerate up to a 50% dip in line voltage before lamp drop out.

Additionally, this same circuit is also used on ballasts for two-lamp series circuits. With the isolated feature, the screw shells of the two-lamp sockets can be connected together and grounded to provide an important safety feature in the fixture.

BALLAST CIRCUITRY

REGULATION OF HIGH PRESSURE SODIUM LAMPS

Volt-Watt Traces

The voltage of a typical Mercury or Metal Halide lamp remains fairly constant throughout its operational life. For this reason, regulation of these ballasts can be defined as a simple $\pm\%$. With a High Pressure Sodium lamp, however, the arc tube voltage increases significantly during the operational life of the lamp.

The High Pressure Sodium lamp ballast must therefore compensate for this changing lamp voltage in order to maintain a somewhat constant wattage even at nominal input.

Consequently, a simple $\pm\%$ regulation is not an adequate definition for a HPS lamp regulation. Instead, a boundary picture called a trapezoid is defined for this dynamic system which restricts the performance of the lamp and the ballast to certain acceptable limits which are established by the American National Standards Institute (ANSI). The ballast is designed to operate a High Pressure Sodium lamp throughout its life within this trapezoid for any input voltage within the rated input voltage range of the ballast.

BALLAST CIRCUITRY

The resultant lamp wattage, as a function of the rising lamp voltage, is called a volt-watt trace:

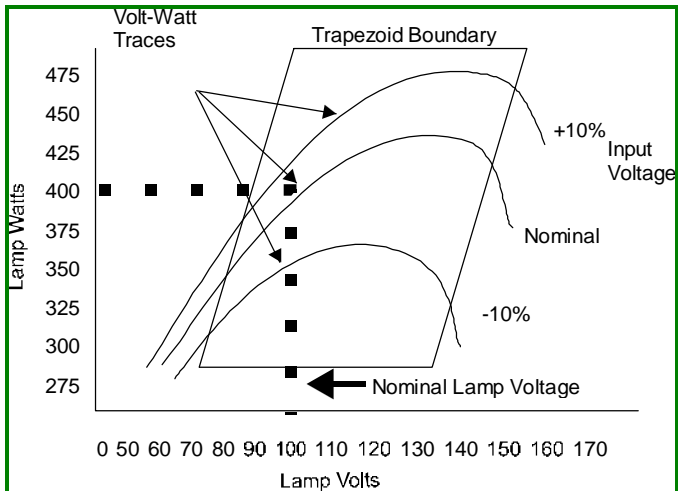

Taken from an Advance data sheet describing the 77A8402 series ballast operating a 400 watt HPS lamp, this volt-watt trace includes curves at nominal input voltage, at plus 10%, and at minus 10% of nominal. The portions of the curves within the trapezoid boundary define operation for this particular lamp-ballast combination over the life of the lamp.

BALLAST CIRCUITRY

CIRCUIT TYPES FOR HIGH PRESSURE SODIUM LAMPS

Reactor (R)

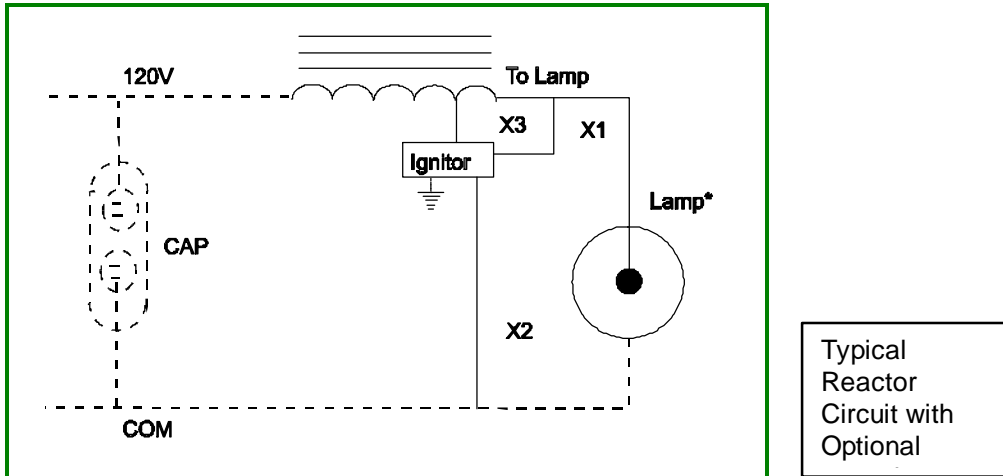

For an input of 120 volts, the simplest and most economical way to ballast a 35 thru 150 watt (55-volt) lamp is by utilizing reactor circuitry because these lamps require a 120 volt open circuit starting potential. Here, the reactor performs only the basic function of controlling current through the lamp.

Although inherently normal power factor (50%), a capacitor may be used with a reactor ballast to provide high power factor (30%) operation. However, the addition of a capacitor will not improve the regulation of the ballast.

BALLAST CIRCUITRY

HIGH REACTANCE AUTOTRANSFORMER (HX)

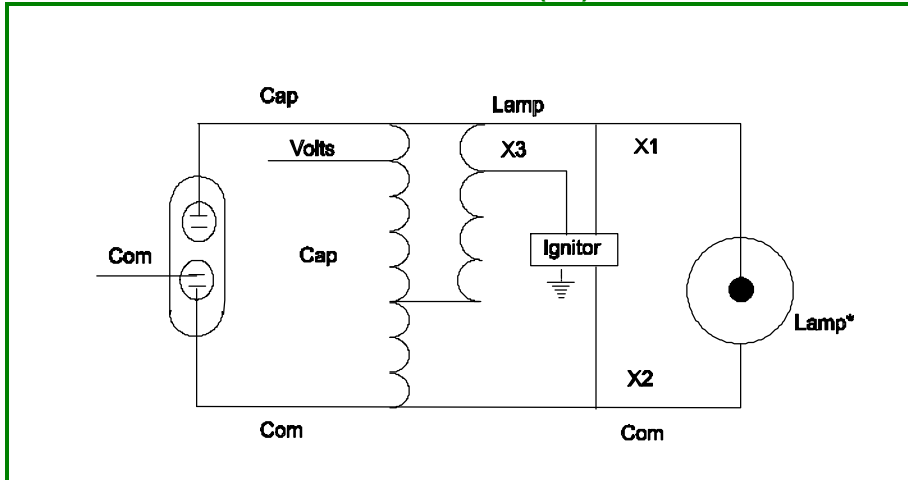

Typical High Reactance Autotransformer Circuit

For 35 thru 150 watt (55 volt) lamps, where the input voltage does not meet the starting voltage requirements of the lamp, such as 208, 240, 277 or 480 volts, the high reactance autotransformer circuit is used and its operating characteristics are similar to the HPS reactor. In addition to limiting the current to the lamp, the autotransformer reduces the input to the 120 volts required to start and operate the lamp. The ballast employs two coils, primary and secondary. It is called an autotransformer because the primary and secondary share common windings.

Also, like the reactor ballast, the autotransformer is inherently normal power factor (50%), but it is generally corrected to high power factor (90%) with the addition of a capacitor. However, this correction will not affect its lamp regulation characteristics. Its current draw and ability to withstand voltage dips are similar to that of the reactor.

BALLAST CIRCUITRY

Constant Wattage Autotransformer (CWA)

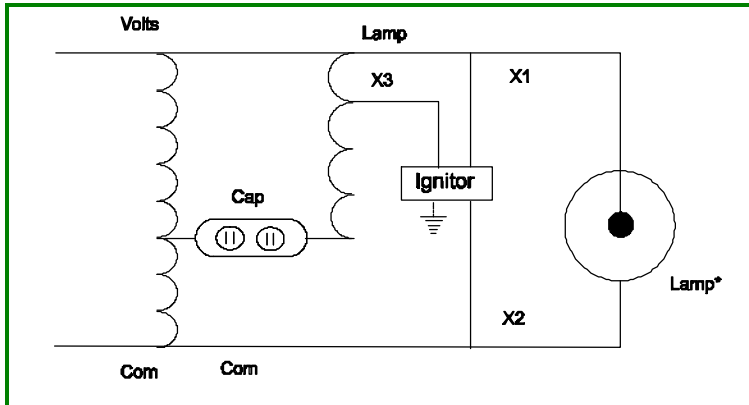

Typical Constant Wattage Autotransformer Circuit

This lead circuit is the most popular of all because it offers excellent regulation at a moderate cost. It is similar to the CWA circuit used with Mercury and Metal Halide lamps. A capacitor is utilized in series with the secondary coil of the ballast and the lamp. The power factor of CWA ballasts exceeds 90%. Lamp regulation is much finer than with the reactor and high reactance circuits. At a +/- 10% variation in line voltage, the ballast will operate the lamp within its defined trapezoidal boundary.

Additionally, the ballast input current during lamp warm-up does not exceed the current when the lamp is stabilized. The incidence of accidental lamp outage is also reduced because a CWA ballast can tolerate an approximate 25% drop in line voltage before lamp drop-out.

BALLAST CIRCUITRY

Regulated Lag (REG. LAG)

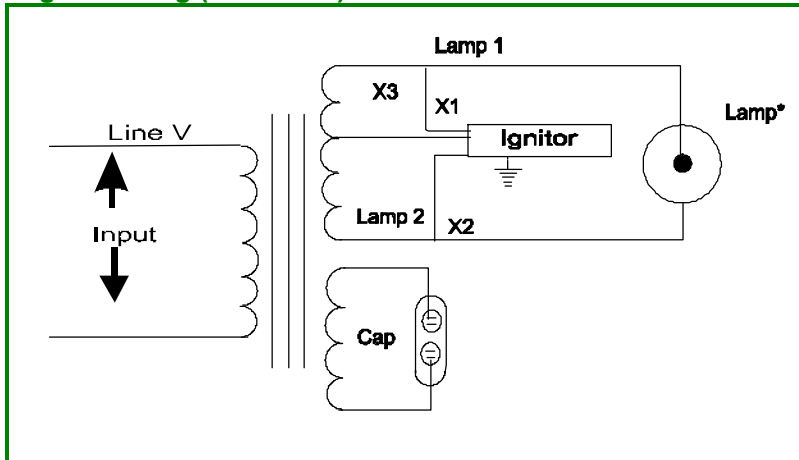

Typical Regulated Lag Circuit

This circuit provides much better regulation than the reactor, high reactance autotransformer or constant wattage autotransformer circuits, but at an increase in ballast size, losses, and price. A ballast incorporating this circuit consists of three coils instead of the usual two or one, with the third coil and its capacitor stabilizing the lamp.

In this circuit, the secondary windings are isolated from the primary, providing a degree of added safety during lamp change-out on live circuits.

BALLAST CIRCUITRY

ALTERNATE TERMINOLOGY

CIRCUIT	SYMBOL
REACTOR Choke Lag	R
HIGH REACTANCE AUTOTRANSFORMER Lag	HX
CONSTANT WATTAGE AUTOTRANSFORMER Lead Peak (Metal Halide & High Pressure Sodium)	CWA
CONSTANT WATTAGE Magnetic Regulator (Mercury & High Pressure Sodium) Regulated Lag (High Pressure Sodium)	CW

BALLAST CIRCUITRY

BALLAST CIRCUITRY CHARACTERISTICS COMPARISON

This chart permits a quick comparison of the various attributes of the four basic ballast circuits. The *size* and *cost* numbers in this chart are relative values shown only as points of reference.

Circuitry Characteristics Which Affect Lighting Performance

	BALLAST CIRCUIT			
	Reactor (R)	Hi-Reactance Autotransformer (HX)	Constant Wattage Autotransformer (CWA)	Constant Wattage (CW)
Lamp Watts Regulation	Poor	Poor	Good	Excellent
Ballast Losses	Low	Low	Medium	High
Power Factor	50/90	50/90	90 Avg.	90-100
Starting & Open Circuit Currents	Greater	Greater	Less	Less
Lamp Life	Excellent	Excellent	Good	Good
Input Voltage Dip Withstand	Poor	Poor	Good	Excellent
Isolation	No	No	No	Yes
Relative Cost	1 - 1.2	1.2 - 1.5	1.5	3

BALLAST-TO-LAMP REMOTE MOUNTING DISTANCES

MERCURY VAPOR AND METAL HALIDE BALLASTS

The distances at which most Mercury Vapor and Metal Halide ballasts can be located from their respective lamps are limited by the ballast-to-lamp wire size. The exceptions being the ballasts for the new, low-wattage Metal Halide lamps which require an ignitor for starting. The mounting distances for these are limited by the ignitor as shown on the following page. Use this chart to determine the minimum wire size required for the Mercury and Metal Halide lamps shown:

LAMP			MAXIMUM ONE-WAY LENGTH OF WIRE BETWEEN LAMP AND BALLAST (FEET) (Voltage Drop Limited to 1% of Lamp Voltage) Minimum Wire Size				
Wattage	Mercury	Metal Halide	#10	#12	#14	#16	#18
100	H38	—	750	470	295	185	115
175	H39	M57	425	265	165	105	65
250	H37	M58	300	190	120	75	45
1-400 or 2-400	H33	M59	200	125	75	50	30
700	H35	—	465	290	180	115	70
1000	H36	M47	325	205	125	80	50
1500	—	M48	225	140	85	55	35

BALLAST-TO-LAMP REMOTE MOUNTING DISTANCES

HIGH PRESSURE SODIUM BALLASTS (and Low-wattage Metal Halide Ballasts)

Remote ballast-to-lamp mounting distances for these ballasts are limited by the capabilities of the ignitor because the ignitor must always be mounted with the ballast.

ADVANCE® Core & Coil type ballasts (71A Series), including Potted Core & Coil types (73B Series), because they are intended for mounting in the fixture, are normally furnished with short range ignitors. For special applications, long range ignitors are available as options. The chart on page 33 indicates maximum allowable distances for remote mounting applications of these ballasts.

ADVANCE® Indoor Enclosed (78E Series), Outdoor Weatherproof (79W Series), Postline (74P Series) and Dual-Volt, F-Can (72C Series) ballasts are normally furnished with built-in, long range ignitors. The maximum allowable ballast-to-lamp mounting distances vary with the basic ballast design as shown in the chart on page 34.

BALLAST-TO-LAMP REMOTE MOUNTING DISTANCES

IGNITOR APPLICATIONS

ADVANCE[®] Core & Coil (71A Series) and Potted Core & Coil (73B) Series

All Other Advance Ballasts

Lamp Type	Case Type	Lamp Watts & Type	Type of Ballast Circuit	Standard SHORT RANGE IGNITOR		Standard LONG RANGE IGNITOR	
				Catalog Number	Max. Dist. To Lamp	Catalog Number	Max. Dist. To Lamp
High Pressure Sodium	Round	35W (S76) thru 150W (S55)	CWA Hi-Reactance Reactor	LI551-J4 LI551-H4 LI551-J4	5 Ft. 2 Ft. 2 Ft.	Not Avail. LI551-J4 LI551-J4	— 35 Ft. 15 Ft.
		150W (S56) thru 400W (S51)	CWA Reg. Lag	LI501-H4	2 Ft.	LI501-J4	50 Ft.
	Oval	250W (M80) 1000W (S52)	HX-HPF CWA	LI520-H5 LI571-H5	5 Ft. 2 Ft.	Not Avail. LI571-J5	— 50 Ft.
Metal Halide	Oval	70W (M85) 100W (M90) 150W (M81)	HX-HPF HPF-Lag HX-HPF	LI520-H5 LI530-H5 LI520-H5	5 Ft.	Not Avail.	—

BALLAST-TO-LAMP REMOTE MOUNTING DISTANCES

IGNITOR APPLICATIONS

All Other Advance Ballasts

ADVANCE BALLAST TYPE	LAMP WATTS & TYPE	MAXIMUM BALLAST DISTANCE TO LAMP
F-Can (72 Series)	All HPS 70W H.Q.I. 100W Metal Halide	15 Ft. 5 Ft. 5 Ft.
Post Line (74P Series)	35 – 70W HPS 100 & 150W HPS	10 Ft. 5 Ft.
Indoor Enclosed (78E Series)	All HPS	50 Ft.
Outdoor Weatherproof (79W Series)	All HPS	50 Ft.

CAPACITORS

GENERAL

All Constant Wattage Autotransformer, high power factor Reactor and Hi-Reactance ballasts require a capacitor. With core & coil units, this capacitor is a separate component and must be properly connected electrically. In high power factor ADVANCE® outdoor weatherproof, indoor enclosed, F-can and postline ballasts, the capacitor is already properly connected within the assembly. Two general types of capacitors are currently in widest use: the oil-filled and the dry type.

OIL-FILLED CAPACITORS



Oil-filled capacitors furnished today contain a non-PCB oil and are equipped with UL component-recognized, internal interrupters to prevent can rupture and resultant oil leakage in the event of failure. Additionally, capacitors utilized with Mercury and Metal Halide CW and CWA ballast circuits have a UL-required discharge resistor connected across the terminals to discharge the capacitor after the power is extinguished for the safety of service personnel. In High Pressure Sodium lighting applications, a discharge resistor contained within the ignitor meets this safety requirement.

Some precautions must be taken when an oil-filled capacitor is installed. Underwriters' Laboratories, Inc. requires the fixture manufacturer to provide a clearance of at least 1/2" above the terminals to allow for expansion of the capacitor in the event of failure.

CAPACITORS

Whether furnished singly or as pairs prewired in parallel, capacitors must be properly wired in all installations. Proper wiring methods, as well as some common miswiring methods which must be avoided, are shown on the following page. If the capacitor is miswired, ballast or lamp failure could result.

CAPACITOR WIRING

Single Capacitors

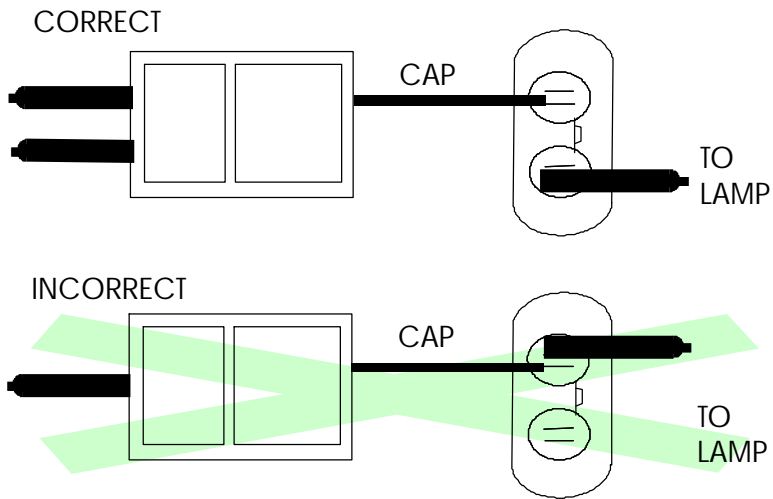

CAPACITORS

Dual Capacitors

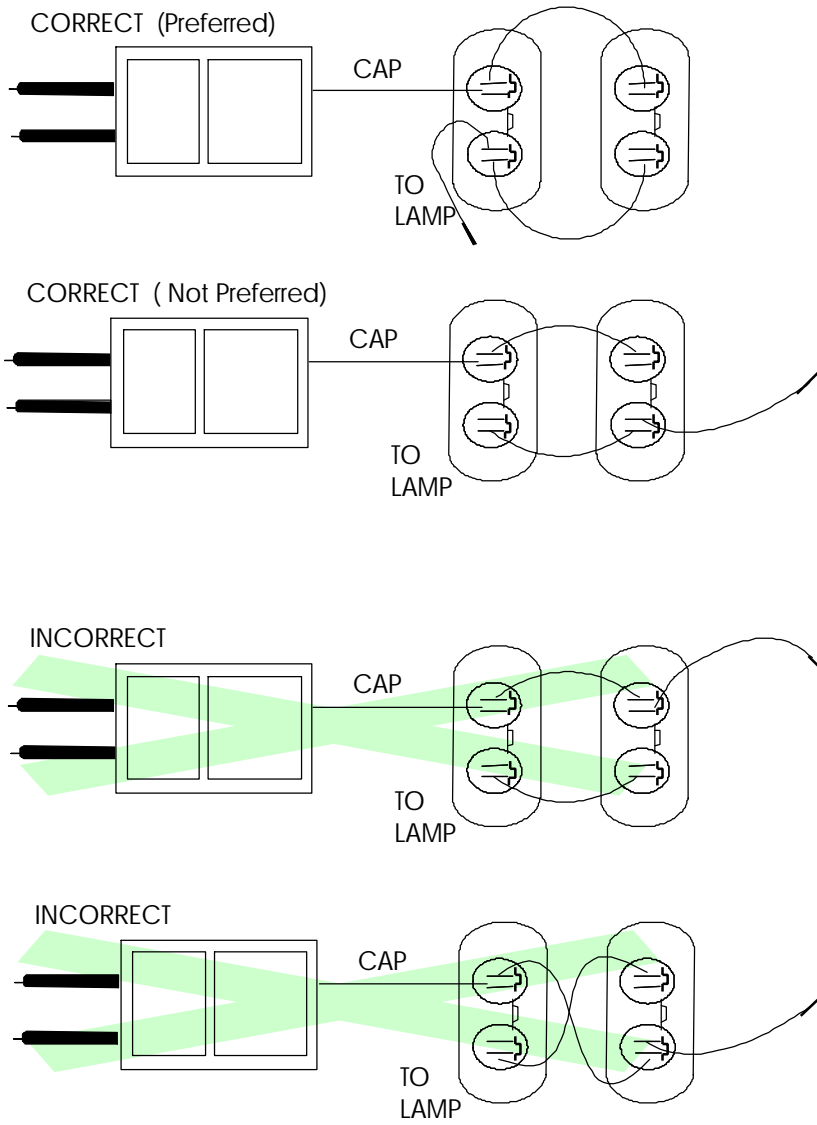

CAPACITORS

DRY METALIZED FILM CAPACITORS



Dry, metalized-film capacitors are relatively new to the lighting industry and are not yet available in all ratings for all applications. However, they are rapidly gaining popularity because of their compact size and extreme ease of installation.

Unlike the oil-filled type of capacitor, the dry type is virtually foolproof to install, requiring only the wiring of the two leads. Because these units contain no oil, they are inherently "non-PCB". Additionally, dry type capacitors utilize a thermoplastic case which does not require grounding.

ADVANCE® dry-type capacitors typically require only half the space used by oil-filled units. Clearance problems within a fixture are eliminated because dry type units have no exposed live parts nor oil-filled cans which may expand. The compact, lightweight, cylindrical shape can therefore fit more easily into the fixture.

CAPACITORS

CAPACITOR FAILURE

The older, PCB oil-filled capacitors, which have been discontinued but may still be found in older fixtures, generally fail shorted when they fail. A shorted capacitor affects ballast types and circuits as follows:

Mercury and Metal Halide Ballasts

A seemingly normal lamp operation, but a large increase in line current. This increased current will usually cause the ballast primary coil to burn up in anywhere from a few minutes to a few days.

High Pressure Sodium (HX & R) Ballasts

A direct short is created across the primary which may either open the circuit breaker or burn-up the primary.

High Pressure Sodium (CWA & CW) Ballasts

Lamp operation continues at a very low wattage and resultant low light output with no damage to the ballast.

The newer, non-PCB, oil-filled capacitors which are presently being furnished contain integral interrupters so the majority of capacitor failures will result in an apparent open circuit. In CWA circuits (the most widely used), this will prevent the lamp from lighting. In HX-HPF circuits, capacitors failing open will result in NPF operation, which means the current drawn by the fixture approximately doubles. In turn, this could cause a fuse to blow, a circuit breaker to open, a ballast primary to fail, or it could have no detrimental effect (depending on the particular ballast used). NOTE: To perform electrical tests on capacitor, refer to page 58.

IGNITORS

GENERAL

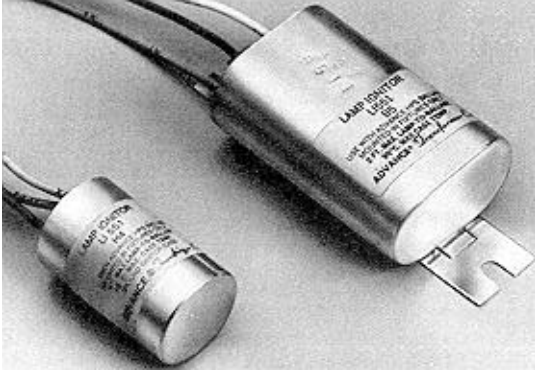

In order to start the lamp, an electronic component called an ignitor must be included in the circuitry of all High Pressure Sodium and certain new low-wattage Metal Halide lighting systems. This ignitor provides a pulse of at least 2500 volts peak in order to initiate the lamp arc.

When the system is energized, the ignitor provides the required pulse until the lamp is lit. It automatically stops pulsing once the lamp has started. It also furnishes this continuous pulse when the lamp has failed or the socket is empty.

The average life of an ignitor is a function of its operating temperature during the continuous pulsing mode. Operation at lower temperatures provides longer ignitor life. All ADVANCE" ignitors incorporate an extended-life design, which assures a comparatively longer life under all operating conditions. No additional internal "turnoff" features are required within the ignitor.

IGNITORS

Ignitor operating temperatures vary considerably with their particular application. A curve showing the average operating life of ADVANCE Long-Life Ignitors at various case temperatures is shown on page 43. When using this curve to estimate ignitor life, remember that the operating life is only that time when the ignitor is in the continuous pulsing mode.

NOTE: For tests to determine if an ignitor is operable, refer to page 64.

IGNITORS

EXAMPLES OF IGNITOR ESTIMATED OPERATING LIFE (Refer to curve on following page)

Under normal conditions, an ignitor actually operates for only a few cycles, once each day, when the lights are started. The ignitor case temperature at this time is the ambient room temperature. Under these conditions, the actual ignitor life expended is insignificant (less than one second per day). Even if the lights were turned off momentarily, once each day, it requires only about one minute of pulsing by the ignitor to restrike the lamp. Assuming an ignitor case temperature of 90°C (worst case), an operating period of one minute per day would total only about five hours of actual operation per year. Since average ignitor life at 90°C is a total of 800 hours, the use of five hours per year is only an insignificant portion of the total time.

However, ignitor life can be used up at a significant rate when an inoperative lamp remains in an energized socket for extended periods of time. In this instance, the ignitor may be pulsing from 8 to 24 hours per day, depending on the lighting application. Experience has shown ignitor case temperatures typically run about 15°C over fixture ambient. Assuming a very severe application with a 75°C case temperature, a total of 10,000 hours of continuous pulsing can be expected. However, if it were pulsing 24 hours per day, this would result in a total ignitor life of just over one year.

IGNITORS

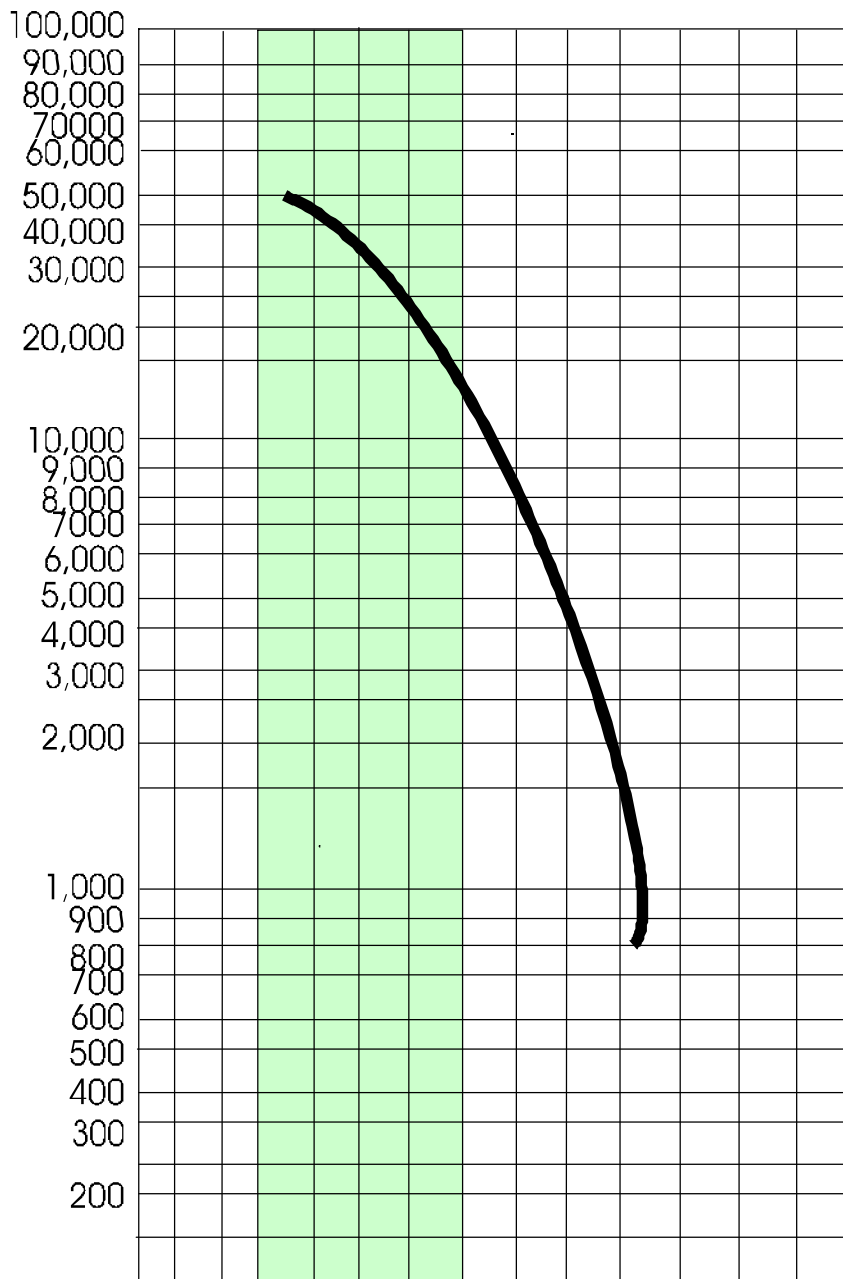

TROUBLESHOOTING

At times when an HID Lighting System becomes inoperative, a complex, thorough, trouble-shooting procedure may prove overly time consuming. In these instances, a simple check of the power switches, when a bank of fixtures becomes inoperative, or a visual check of the lamp, when a singular fixture becomes inoperative, may provide the quickest response to the problem. At other times, where individual isolated fixtures are involved, it may be necessary to systematically isolate the problem and perform complete electrical tests in order to properly restore the lighting.

The four basic trouble-shooting methods outlined in this booklet offer procedures which can be applied to cover virtually all situations:

1. Visual Inspection Check List

Quick visual checks for normal end-of-lamp life and application irregularities not requiring electrical testing (Page 45).

2. Quick Fix For Restoring Lighting

Where lighting must be immediately restored (Page 47).

3. Troubleshooting Flow Charts

Simplified diagrams to quickly locate the problem in any given lighting fixture based on the lamp characteristics (Page 48).

A. Lamp will not start (Pages 48-50)

B. Lamp cycles (Page 51)

C. Lamp too bright or dim (Page 52)

4. Electrical Tests-In-depth check of system by performing electrical tests (Page 53).

1. VISUAL INSPECTION CHECK LIST NORMAL END OF LAMP LIFE

Mercury and Metal Halide Lamps

These lamps at end-of-life are characterized by low light output and/or intermittent starting. Visual signs include blackening at the ends of the arc tube and electrode tip deterioration.

High Pressure Sodium Lamps

Aged HPS lamps will tend to cycle at end-of-life. After start-up, they will cycle off and on as the aged lamp requires more voltage to stabilize and operate the arc than the ballast is capable of providing.

Visual signs include a general blackening at the ends of the arc tube. The lamp may also exhibit a brownish tinge (sodium deposit) on the outer glass envelope.

Low Pressure Sodium Lamps

At end-of-life these lamps retain their light output but starting first becomes intermittent and then impossible. Visual signs include some blackening of the ends of the arc tube.

TROUBLESHOOTING

1. VISUAL INSPECTION CHECKLIST ADDITIONAL CHECKS

LAMPS

Broken arc tube or outer lamp jacket.

Lamp broken where glass meets the base.

Broken or loose components in lamp envelope.

Arc tube end blackening.

Deposits inside outer glass envelope.

Lamp type (H,M,S, or L number) and wattage must correspond to that required by ballast label.

Lamp orientation designation (BU or BD) incorrect for application (base up, base down, etc.).

LIGHTING SYSTEM COMPONENTS

Charred ballast coils.

Damaged insulation or coils on ballast.

Evidence of moisture or excessive heat.

Loose, disconnected, pinched or frayed leads.

Incorrect wiring.

Swollen or ruptured capacitor.

Damaged ignitor.

TROUBLESHOOTING

2. QUICK FIX FOR RESTORING LIGHTING

Visual Inspection

Visually inspect lamp, ballast, capacitor and ignitor (where used) for physical signs of failure, replacing any apparently defective components.

If either core & coil ballast or capacitor appear abnormal, replace both.

Component Replacement Where No Visual Defects Appear

Verify that the correct line voltage is being supplied to the fixture.

Check power switches, circuit breakers, fuses, photo control, etc.

Replace lamp.

Replace ignitor (where used).

Replace both ballast and capacitor.

TROUBLESHOOTING

3. FLOW CHARTS

A. Lamp Will Not Start (STEP 1)

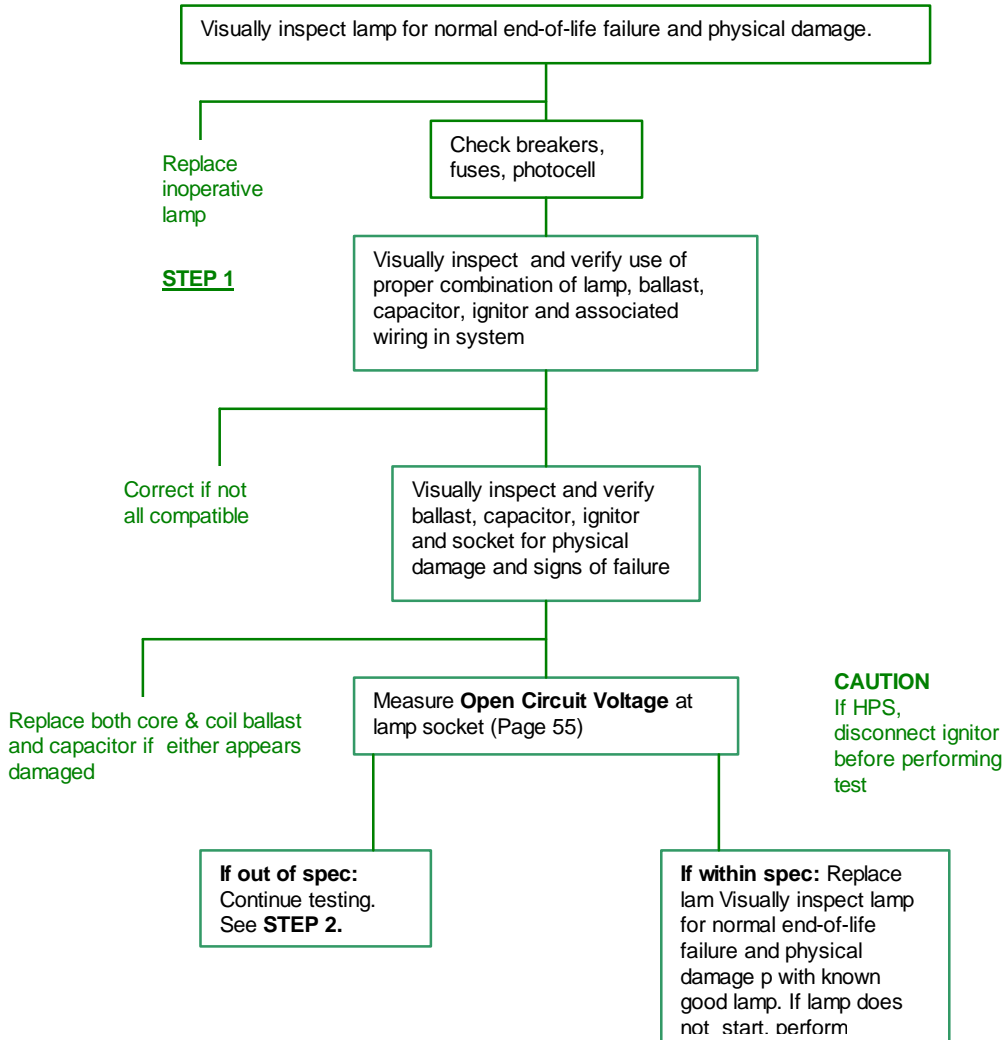

TROUBLESHOOTING

A. Lamp Will Not Start (STEP 2)

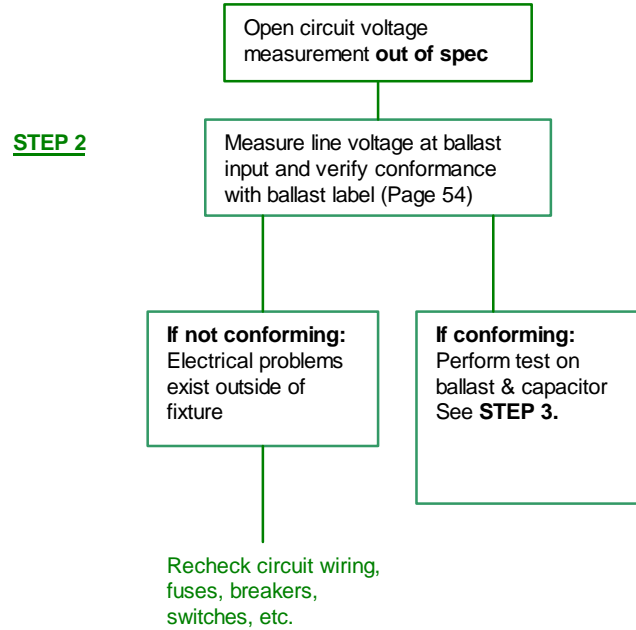

TROUBLESHOOTING

A. Lamp Will Not Start (STEP 3)

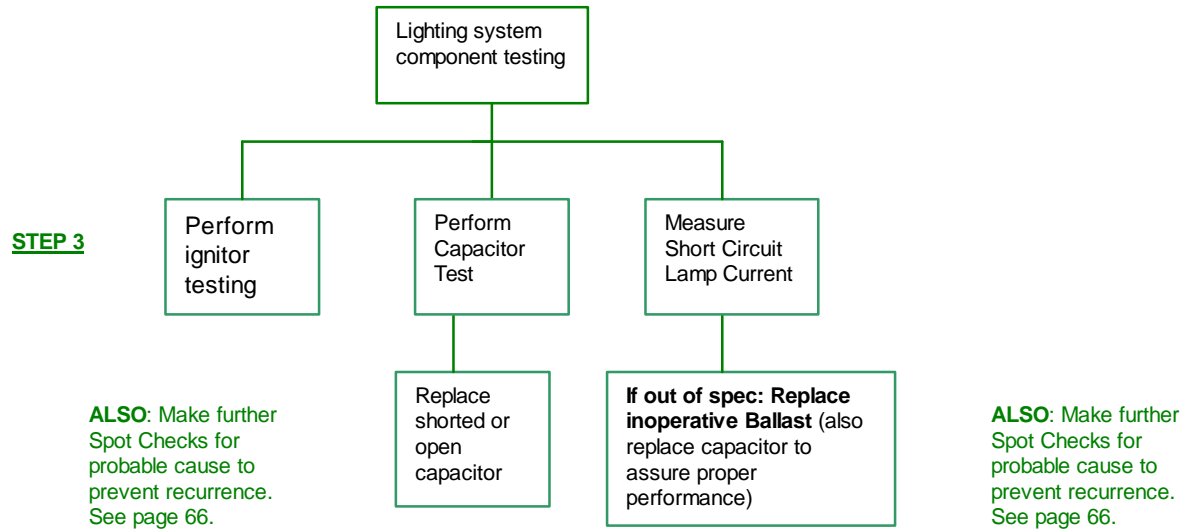

TROUBLESHOOTING

B. Lamp Cycles

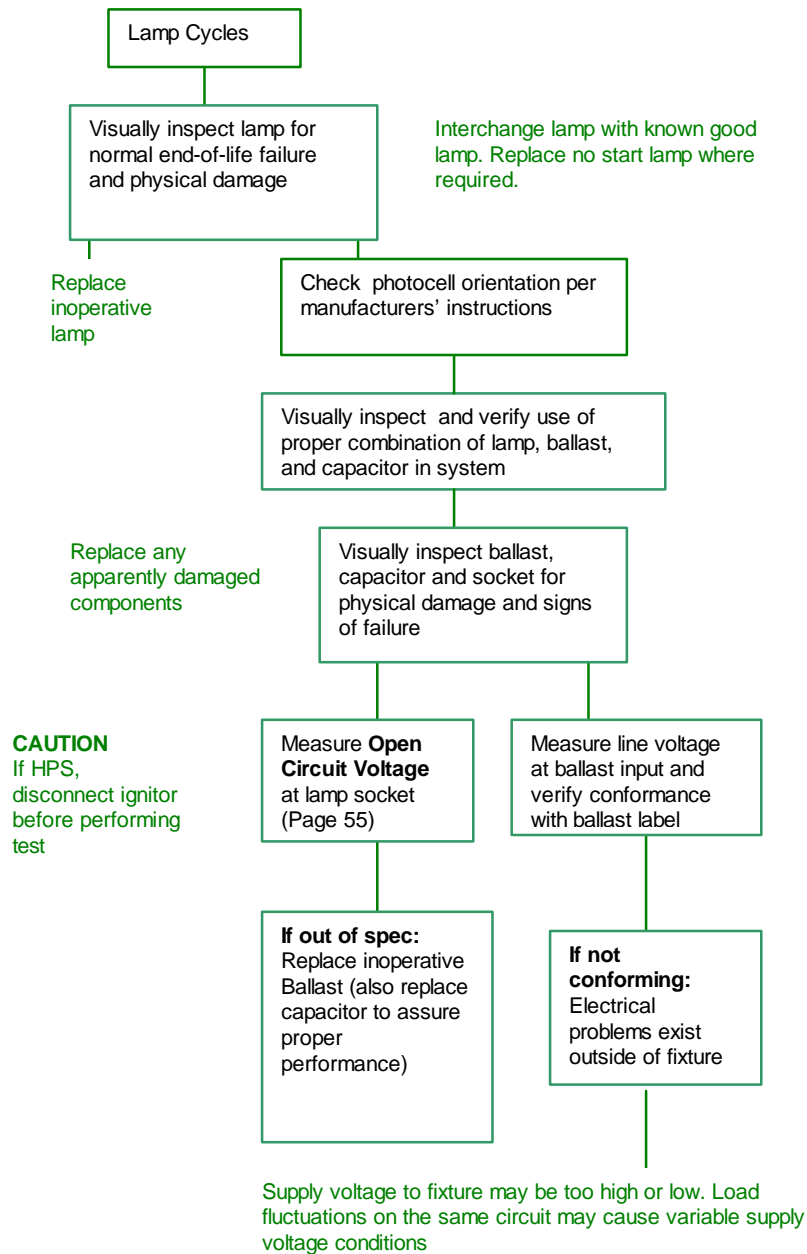

TROUBLESHOOTING

C. Lamp Too Bright or Dim

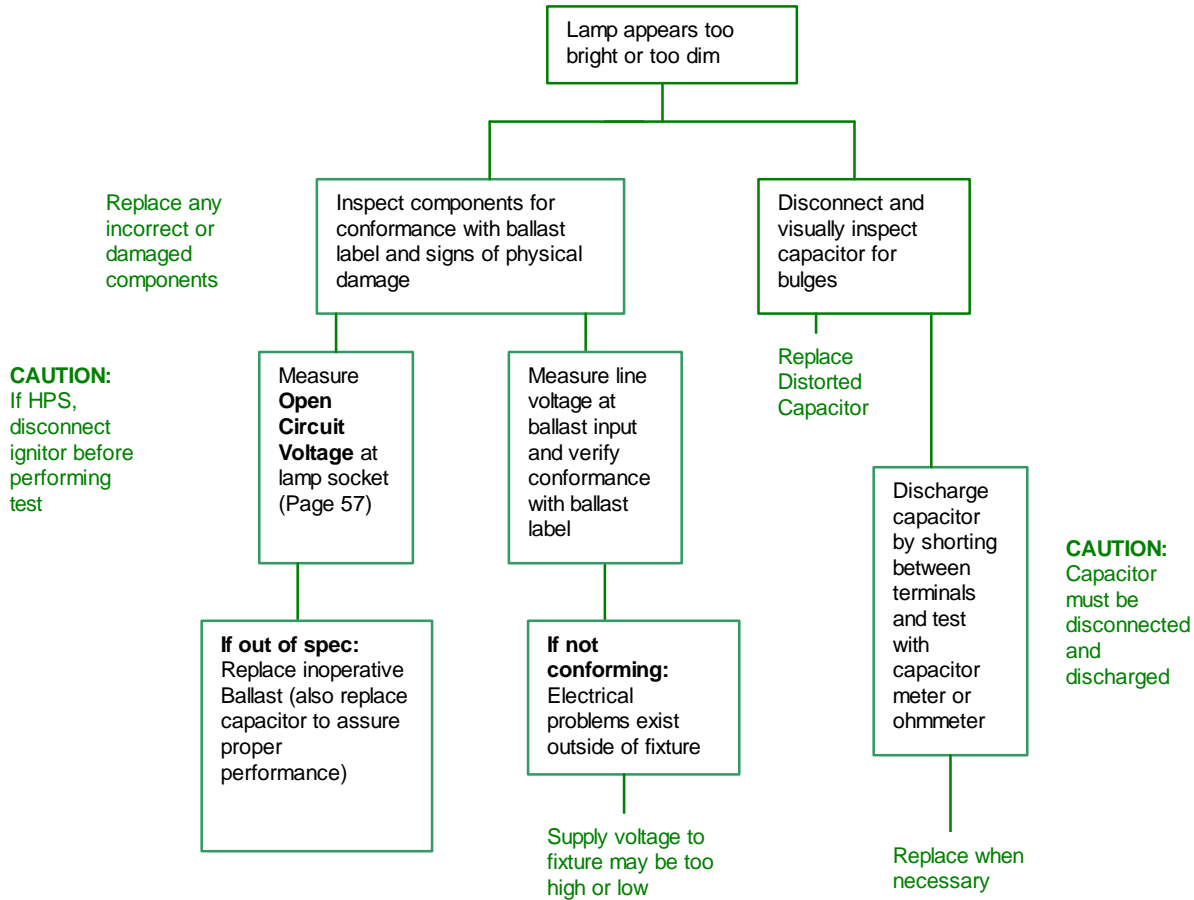

TROUBLESHOOTING

4. ELECTRICAL TESTS

NOTE: Voltage and current measurements present the possibility of exposure to hazardous voltages and should be performed only by qualified personnel.

The following equipment is recommended for testing HID fixtures:

RMS Voltmeter

Ranges: 0-150-300-750 Volts AC

Ammeter (Clamp-on type acceptable)

Ranges: 0-1-5-10 Amperes AC

Multi-meter (with voltage and current ratings as shown above).

Ohmmeter



TROUBLESHOOTING

LINE VOLTAGE

Measure the line voltage at input to fixture to determine if the power supply conforms to the requirements of the lighting system. For constant wattage ballasts, the measured line voltage should be within 10% of the nameplate rating. For high reactance or reactor ballasts, the line voltage should be within 5% of the nameplate rating.

If the measured line voltage does not conform to the requirements of the lighting system, as specified on the ballast or fixture nameplate, electrical problems exist outside of the fixture which can result in non-starting or improper lamp operation.

Check fuses, breakers and switches when line voltage readings cannot be obtained. High, low or variable voltage readings may be due to load fluctuations on the same circuit.

TROUBLESHOOTING

OPEN CIRCUIT VOLTAGE

To determine if the ballast is supplying proper starting voltage to the lamp, an open circuit voltage test is required. The proper test procedure is:

1. Measure input voltage (V1) to verify rated input voltage is being applied.
2. With the lamp out of the socket and the proper voltage applied to the ballast, read the voltage (V2) between the socket pin and shell. Reading must be within test limits shown.

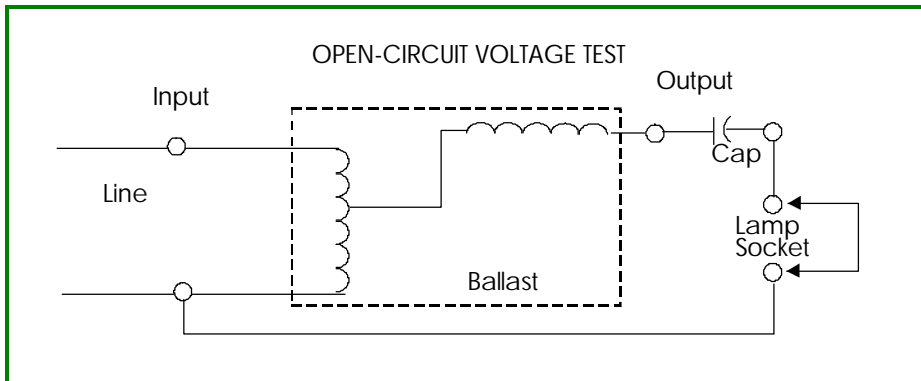

As an alternative, this test may also be performed simply by screwing an adapter into the lamp socket for easy access. Then hook up the voltmeter to this adapter. Reading must be within test limits shown.

TROUBLESHOOTING

OPEN-CIRCUIT VOLTAGE TEST LIMITS

	LAMP		RMS VOLTAGE
	Wattage	ANSI Number	
MERCURY BALLASTS	50	H46	225-255
	75	H43	225-255
	100	H38	225-255
	175	H39	225-255
	250	H37	225-255
	400	H33	225-255
	2-400 (ILO)	2-H33	225-255
	2-400 (Series)	2-H33	475-525-
	700	H35	405-455
	1000	H36	405-455
METAL HALIDE BALLASTS	70	M85	210-250
	100	M90	250-300
	150	M81	220-260
	175	M57	285-320
	250	M80	230-270
	250	M58	285-320
	400	M59	225-255
	2-400 (ILO)	2-M59	225-255
	2-400 (Series)	2-M59	600-665
	1000	M47	400-445
	1500	M48	400-445
HIGH PRESSURE SODIUM BALLASTS	35	S76	110-130
	50	S68	110-130
	70	S62	110-130
	100	S54	110-130
	150	S55	110-130
	150	S56	200-250
	200	S66	200-230
	250	S50	175-225
	310	S67	155-190
	400	S51	175-225
1000	S52	420-480	
LOW PRESSURE SODIUM BALLASTS	18	L69	300-325
	35	L70	455-505
	55	L71	455-505
	90	L72	455-525
	135	L73	645-715
	180	L74	645-715

TROUBLESHOOTING



Open Circuit Voltage rest at Socket



Open Circuit Voltage rest at Socket Head Connection

WHEN OPEN CIRCUIT VOLTAGE TEST RESULTS IN NO READING

Further checks should be made to determine whether cause is attributable to lamp socket short, shorted or open capacitor, inoperative ballast, improper wiring or open connection. Simple checks may be made as follows:

Shorted Socket Check

1. Turn off power and remove lamp from socket.
2. Check for internal short in lamp socket with continuity meter across two lamp leads.
3. Should read NO continuity.

TROUBLESHOOTING

CAPACITOR CHECK

1. Disconnect capacitor from circuit.
2. Discharge capacitor by shorting between terminals.
3. Check capacitor with ohmmeter set at highest resistance scale:

If meter indicates a very low resistance which then gradually increases, the capacitor does not require replacement.

If meter indicates a very high resistance which does not diminish, it is open and should be replaced.

If meter indicates a very low resistance which does not increase, the capacitor is *shorted* and should be *replaced*.



Capacitor Check

TROUBLESHOOTING

BALLAST CONTINUITY CHECK

Continuity of Primary Coil

1. Disconnect ballast from power supply and discharge the capacitor.
2. Check for continuity of ballast primary coil between input leads.

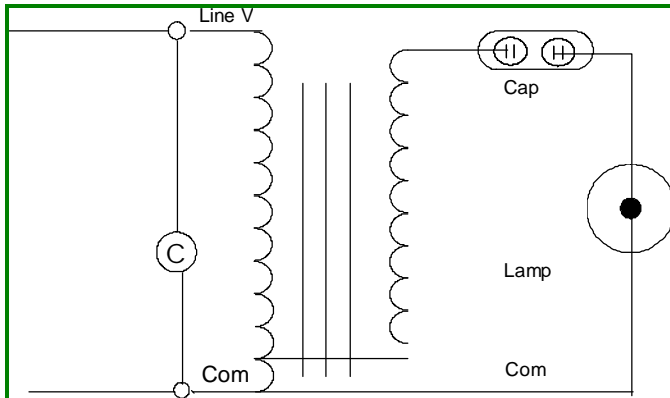

Between Common
and Line Leads.

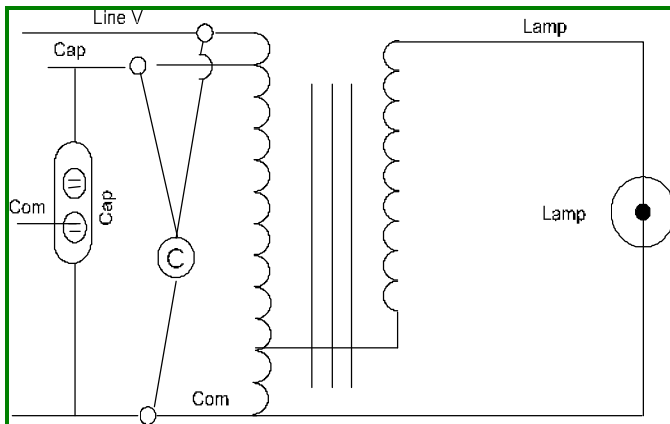

Between Common
and Capacitor
Leads.

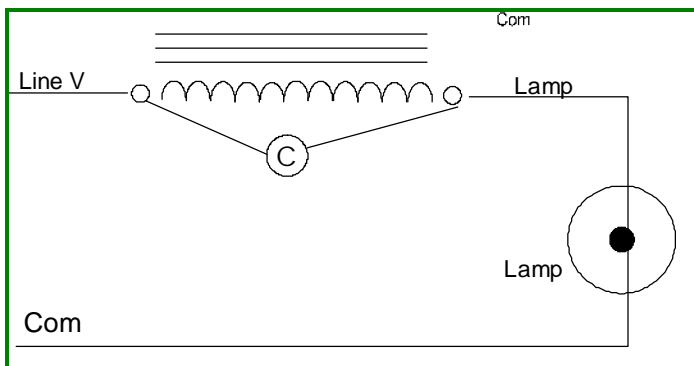

Between Line and
Lamp Leads.

TROUBLESHOOTING

Continuity of Secondary Coil

1. Disconnect ballast from power supply and discharge the capacitor.
2. Check for continuity of ballast secondary coil between lamp and common leads.

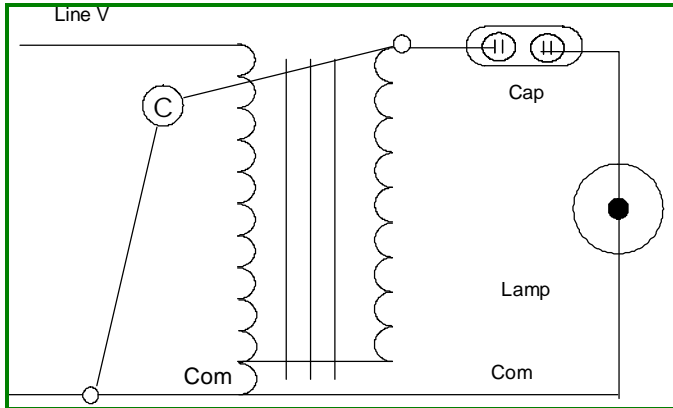

Between Common and
Capacitor Leads.

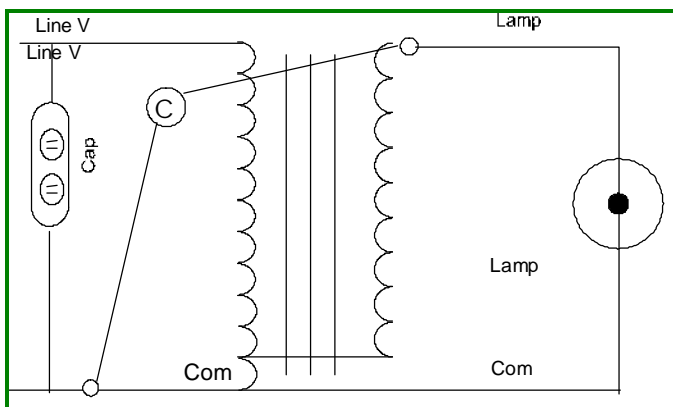

Between Common and
Lamp Leads.

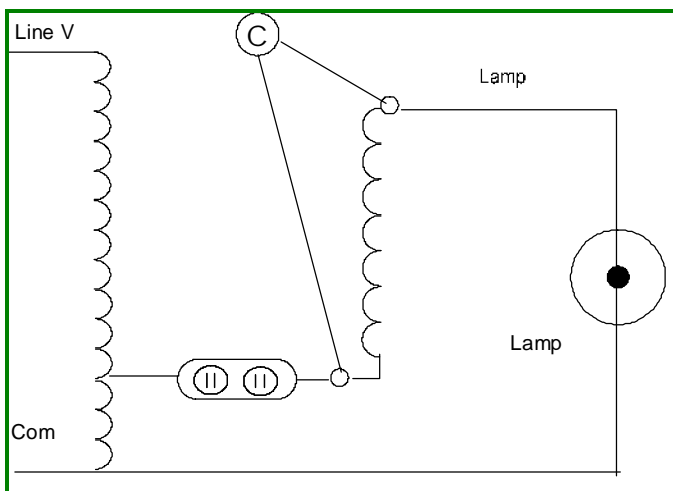

Between Capacitor and
Lamp Leads. Between
Common and Lamp.

TROUBLESHOOTING

SHORT CIRCUIT LAMP CURRENT

To assure the ballast is delivering the proper current under lamp starting conditions, a measurement may be taken by connecting an ammeter between the lamp socket Center pin and the socket shell with rated input voltage applied to the ballast. If available, a socket adapter may be used:

1. Energize ballast with proper rated input voltage.
2. Measure Current with ammeter at A1 and A2 as shown below.
3. Readings must be within test limits shown.

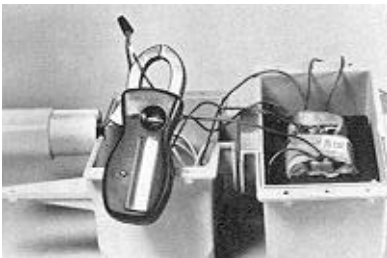
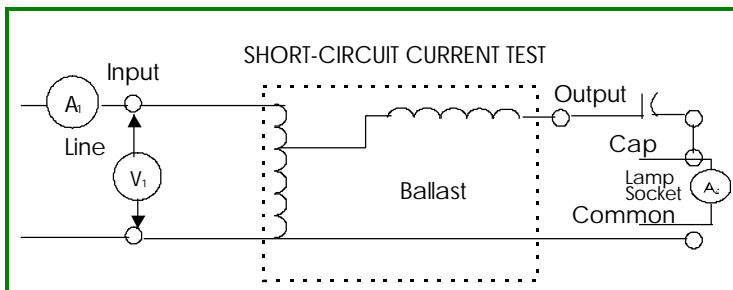

Short Circuit Lamp
Current Test

When using a clamp-on ammeter for this measurement, be certain the meter is not near the magnetic field of the ballast or any steel member which might distort the magnetic field.

TROUBLESHOOTING

SHORT CIRCUIT LAMP CURRENT TEST LIMITS

	LAMP		SECONDARY SHORT CIRCUIT CURRENT AMPS
	Wattage	ANSI Number	
MERCURY BALLASTS	50	H46	.85-1.15
	75	H43	.95-1.70
	100	H38	1.10-2.00
	175	H39	2.0-3.6
	250	H37	3.0-3.8
	400	H33	4.4-7.9
	2-400 (ILO)	2-H33	4.4-7.9
	2-400 (Series)	2-H33	4.2-5.40
	700	H35	3.9-5.85
	1000	H36	5.7-9.0
METAL HALIDE BALLASTS	70	M85	.85-1.30
	100	M90	1.15-1.76
	150	M81	1.75-2.60
	175	M57	1.5-1.90
	250	M80	2.9-4.3
	250	M58	2.2-2.85
	400	M59	3.5-4.5
	2-400 (ILO)	2-M59	3.5-4.5
	2-400 (Series)	2-M59	3.3-4.3
	1000	M47	4.8-6.15
	1500	M48	7.4-9.6
	HIGH PRESSURE SODIUM BALLASTS	35	S76
50		S68	1.5-2.3
70		S62	1.6-2.9
100		S54	2.45-3.8
150		S55	3.5-5.4
150		S56	2.0-3.0
200		S66	2.50-3.7
250		S50	3.0-5.3
310		S67	3.8-5.7
400		S51	5.0-7.6
1000		S52	5.5-8.1
LOW PRESSURE SODIUM BALLASTS		18	L69
	35	L70	0.52-.78
	55	L71	0.52-.78
	90	L72	0.8-1.2
	135	L73	0.8-1.2
	180	L74	0.8-1.2

TROUBLESHOOTING

WHEN SHORT CIRCUIT LAMP CURRENT TEST RESULTS IN HIGH, LOW OR NO READING:

Further checks should be made to determine whether cause is attributed to improper supply voltage, shorted or open capacitor or inoperative ballast. Checks may be made as follows:

Supply Voltage Check

1. Measure Line Voltage as described on page 54.
2. If ballast is multi-voltage unit such as ADVANCE® Quadri-Volt, make certain input voltage connection is made to proper input voltage terminal or lead.

Capacitor Check

1. Verify capacitor rating is as required and shown on ballast label.
2. Perform Capacitor Check as described on page 58.

Ballast check

Perform Open Circuit Voltage test as described on page 55.

HPS IGNITORS

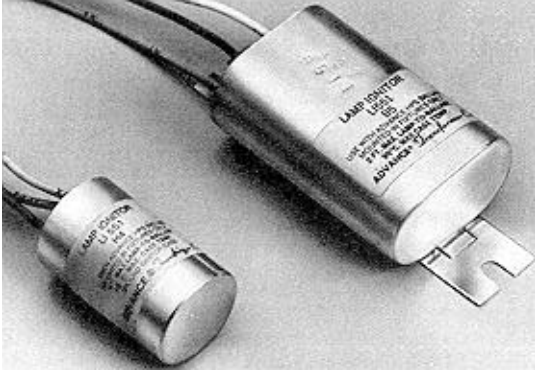

High Pressure Sodium Lamp Ballast Ignitors

Ignitors are used as a starting aid with all high pressure sodium and certain low-wattage metal halide lamps.

Measurement of the starting pulse voltage of an ignitor is beyond the capability of most instruments available in the field. In laboratory tests, an oscilloscope is used to measure pulse height and width. In the field, some simple tests may be performed to determine if the ignitor is operable:

1. Replace the ignitor with another ignitor which is known to be operable. If the lamp then starts, the previous ignitor was either miswired or inoperative.
2. Remove the High Pressure Sodium lamp and replace it with a known operable HPS lamp of proper wattage. If lamp lights, ignitor is operating properly.

TROUBLESHOOTING

3. If lamp does not light, disconnect ignitor and proceed as follows:

A. 35W to 150W (55V) HPS

Insert 120 V incandescent lamp in socket. If lamp lights, ignitor requires replacement. If test lamp fails to light, refer to TROUBLESHOOTING FLOW CHART A on page 50.

B. 150W (100V) to 400W HPS

Install mercury lamp of comparable wattage. If mercury lamp starts—ignitor requires replacement.

If test lamp fails to light, refer to TROUBLESHOOTING FLOW CHART A on page 50.

C. 1000 W

Replace ignitor.

NOTE: Ignitors are not interchangeable. Refer to ballast label for designation of proper ignitor to be used with ballast.

FURTHER CHECKS

Probable Causes of Inoperative Ballast

1. Normal end-of-life failure.
2. Operating incorrect lamps. Use of higher or lower wattage lamps than rated for ballast will cause premature ballast end-of-life.
3. Overheated due to heat from fixture or ambient temperature.
4. Voltage surge.
5. Miswiring or pinched wires
6. Shorted or open capacitor.
7. Incorrect capacitor rating for ballast.
8. Capacitor miswired or wiring shorting against frame.

Probable Causes of Shorted or Open Capacitor

1. Normal end-of-life failure.
2. Overheated due to heat from fixture or ambient temperature.
3. Capacitor heat barrier inadvertently removed.
4. Incorrect voltage rating of capacitor.
5. Mechanical damage such as overtightened bracket.